

**MODEL AM5/AM5e**  
***Classic***  
**WIDEBAND**  
**TRANSMISSION TEST SET**

**INSTRUCTION MANUAL**



**Ameritac**

**MODEL AM5/AM5e**  
***Classic***  
**WIDEBAND**  
**TRANSMISSION TEST SET**

**INSTRUCTION MANUAL**

May 1997

Technical Data Subject to  
Change without Notice

**Ameritec**

760 Arrow Grand Circle  
Covina, CA 91722 USA  
TEL 626.915.5441  
FAX 626.915.7181  
[www.ameritec.com](http://www.ameritec.com)

Test Complete

ISO 9001 Certified Company

For extra copies of  
this manual, order  
Part No. 18-0047G

**RECORD OF REVISIONS**

00	March, 1993	Original Issue
A	August, 1993	Corrections on page 3-5.
B	December, 1993	Corrections on page 4-7, 10-3.
C	April, 1994	Major update
D	June, 1994	Added INDEX
E	October, 1994	Major update
F	August, 1996	Added E-mail address
G	April, 1997	Calibrate Procedure Addendum for new software version.

# **CAUTION**

When using the padded carrying case for the AM5 or AM5e Classic (P/N 87-0070C), DO NOT PLACE the power cord around the side of the case in the manner demonstrated in Figure 1.

Instead, be certain to WIND THE CORD UNDER THE CASING in the Area between the feet, as shown in Figure 2.

Failure to follow this procedure could cause deterioration of the cord and Increase the possibility of electric shock.

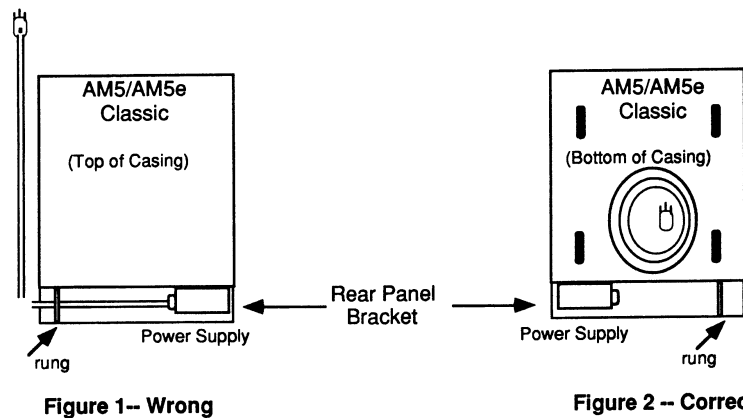

November 19, 1997

## ORGANIZATION OF MANUAL

- SECTION 1** — **OVERVIEW/UNPACKING** describes the models of the AM5 and AM5e Classic that are available and provides guidance for proper unpacking and inspection of the unit.
- SECTION 2** — **POWER CONSIDERATIONS** describes the commercial power requirements, precautions, battery options, and power ON and OFF.
- SECTION 3** — **PHYSICAL AND FUNCTIONAL DESCRIPTION** describes the physical characteristics; front-panel switches, indicators, displays, and connectors; rear-panel power connector, voltage-select switch, fuse location, method of identifying units, and permanent connections. Also described in this section are the Factory-installed options and accessories.
- SECTION 4** — **SELF TEST OPERATIONS** describes the operations which should be performed after the unit is turned on for the first time. Default settings are described and SEND and MEASURE tests that can be performed by connecting the TX/2W to the RX jacks are described. This section also describes restoration of settings before shut down and a full-calibration procedure.
- SECTION 5** — **LINE TEST CONNECTIONS AND CONFIGURATIONS** describes the cables that may be used to connect the unit to the equipment under test. Also covered are schematic diagrams of the line interfaces for the various configurations that can be selected by an operator through the use of the TX/2W, RX, LINE, and DIAL sections of the front panel.
- SECTION 6** — **MEASURE FUNCTIONS AND PARAMETERS** describes each measurement that may be selected by the MEASURE key on the front panel. Included in the description are all parameters that may be changed for each type of measurement. Some typical test configurations are covered.

- SECTION 7 — FILTERS FOR AM5 Classic** describes the Noise-Weighting filters that are provided to IEEE standards. The Filters are switched by the FILTER key into the measurement circuitry for noise tests. Included in these sections are frequency response graphs for each filter type.
- SECTION 8 — FILTERS FOR AM5e Classic** describes the Noise-Weighting filters that are provided to CCITT standards. The Filters are switched by the FILTER key into the measurement circuitry for noise tests. Included in these sections are frequency response graphs for each filter type.
- SECTION 9 — SEND FUNCTIONS AND PARAMETERS** describes each signal generation function that may be selected by the SEND key on the front panel. Included in the description are all parameters that may be changed for each signaling requirement.
- SECTION 10 — AM5/AM5e CLASSIC TECHNICAL SPECIFICATIONS** provides a tabular listing of the specifications for the AM5 Classic and the AM5e Classic.
- SECTION 11 — WARRANTY AND SERVICE POLICY** provides information on warranty and on returning unit to Ameritec for service.

## TABLE OF CONTENTS

<b>CAUTION</b> .....	<b>INSIDE OF FRONT COVER</b>
<b>SECTION 1 — OVERVIEW AND UNPACKING</b> .....	<b>1-1</b>
1.1 OVERVIEW .....	1-1
1.2 UNPACKING .....	1-1
<b>SECTION 2 — POWER CONSIDERATIONS</b> .....	<b>2-1</b>
2.1 COMMERCIAL POWER .....	2-1
<b>CAUTION:</b> .....	<b>2-1</b>
2.2 OPTIONAL BATTERY PACK .....	2-1
2.3 POWER ON AND OFF .....	2-1
<b>SECTION 3 — PHYSICAL AND FUNCTIONAL DESCRIPTION</b> .....	<b>3-1</b>
3.1 PHYSICAL CHARACTERISTICS .....	3-1
3.1.1 Weight .....	3-1
3.1.2 Portable Dimensions .....	3-1
3.1.3 Rack Mounted Dimensions .....	3-1
3.1.4 Construction .....	3-1
<b>CAUTION:</b> .....	<b>3-1</b>
3.1.5 Rubber Feet .....	3-1
3.1.6 Carrying Handle .....	3-1
NOTE .....	3-1
3.2 FRONT PANEL DESCRIPTION .....	3-1
<b>CAUTION</b> .....	<b>3-1</b>
NOTE .....	3-1
3.3.1 ON OFF Button (power switch) .....	3-5
<b>CAUTION</b> .....	<b>3-5</b>
NOTE .....	3-5
3.3.2 TX/2W bantam jack for 2-wire circuits (2W LED on) .....	3-5
3.3.3 TX/2W bantam jack for 4-wire circuits (4W LED on) .....	3-5
3.3.4 TX/2W bantam jack for REVERSE selection (4W REV LED on) .....	3-5
3.3.5 RX bantam jack for 4-wire circuits (4W LED on) .....	3-5
3.3.6 RX bantam jack for 4-wire circuits for REVERSE selection (4W REV LED on) .....	3-5
3.3.7 MONITOR (TX, MEAS, RX) switch .....	3-6
3.3.8 Speaker Volume Control .....	3-6
NOTE .....	3-6
3.3.9 DISPLAY key .....	3-6
3.3.10 Left-Hand 7-Segment Display .....	3-6
3.3.11 Left-Hand LED's (dB, dBm, dBm, mSEC, HOLD TONE) ...	3-6
3.3.12 Right-Hand 7-Segment Display .....	3-8
3.3.13 Units of Measurement LED's (kHz, SEC, MIN, CNT) .....	3-8
3.3.14 PARAM SEL keys (Parameter Select and arrow keys) .....	3-8
NOTE .....	3-8
3.3.15 START/STOP Key (Impulse Noise Measurement) .....	3-10
3.3.16 MEASURE Key .....	3-10

3.3.17	FILTER (left key)	3-11
	NOTE	3-11
3.3.18	FILTER (right key)	3-11
3.3.19	SEND (left key)	3-12
3.3.20	SEND (middle key)	3-12
3.3.21	SEND (right key)	3-12
	NOTE:	3-12
3.3.22	TX/2W (left key)	3-13
3.3.23	TX/2W (right key)	3-13
3.3.24	RX (left key)	3-13
3.3.25	RX (middle key)	3-13
3.3.26	RX right key)	3-13
3.3.27	LINE Key	3-14
3.3.28	DIAL key	3-14
3.3.29	DIAL Terminals:	3-14
3.4	REAR PANEL	3-15
	NOTE	3-15
3.4.1	AC Power Selector Switch	3-15
	<b>CAUTION:</b>	<b>3-15</b>
3.4.2	Fuse Holder	3-15
3.4.3	Power Plug	3-15
3.4.4	Identification Label	3-15
3.4.5	Screw Terminal, Ground	3-16
3.4.6	Screw Terminals, T1 and R1	3-16
3.4.7	Screw Terminals, T and R	3-16
3.5	OPTIONAL FACTORY-INSTALLED EQUIPMENT	3-17
3.5.1	Sealed Lead-Acid Batteries and Integral Charger (Option 24-0017)	3-17
3.5.2	Siemens type "banana" input adapter for AM5e Classic only (Option 25-0041)	3-17
3.5.3	Model 30-0033XT Signalling Adapter with Ring Generator	3-17
3.6	ACCESSORIES	3-18
3.6.1	Line Cables	3-18
3.6.2	Protective front panel (85-0078)	3-18
	NOTE	3-18
3.6.3	Padded Carrying Case (87-0070)	3-18
3.6.4	19" Rack Mounting Kits (85-0076)	3-18
3.6.5	19" Rack Mounting Shelf (85-0233):	3-18
<b>SECTION 4 — SELF TEST AND CALIBRATION</b>		<b>4-1</b>
4.1	SELF TEST CONFIGURATION	4-1
4.2	POWER ON SELF-TEST	4-1
	NOTE	4-1



4.3	DEFAULT SETTINGS .....	4-1
4.3.1	Function LEDs at Power Turn-on .....	4-1
4.3.2	Parameter Settings at Power Turn-on: .....	4-2
	NOTE .....	4-2
4.3.3	Restoring Previous Settings .....	4-3
	NOTE .....	4-3
4.5	LOOPBACK TESTS .....	4-4
4.5.1	Set up .....	4-4
4.5.2	QUIET Test .....	4-4
	NOTE .....	4-5
4.5.3	SEND 1004 Hz Test .....	4-6
	NOTE .....	4-6
	NOTE .....	4-7
4.6	CALIBRATION PROCEDURE .....	4-7
4.6.1	External Test Equipment .....	4-7
4.6.2	Calibration Setup .....	4-7
4.6.3	Calibration Procedure .....	4-8
<b>SECTION 5 — LINE FUNCTIONS .....</b>		<b>5-1</b>
5.1	LINE CABLES .....	5-1
	NOTE .....	5-1
5.2	BLOCK DIAGRAMS OF AM5 AND AM5E CLASSIC .....	5-2
5.2.1	LINE 4W selection .....	5-2
5.2.2	LINE 4W REVerse selection .....	5-2
5.2.3	LINE 2W selection .....	5-3
	NOTE .....	5-3
5.2.4	LINE 2W 2.16 $\mu$ f selection .....	5-3
5.2.5	DIAL terminal DIAL selection .....	5-3
5.2.6	TX/2W 135 $\Omega$ , 150 $\Omega$ , 600 $\Omega$ , 900 $\Omega$ , 1200 $\Omega$ selections .....	5-4
5.2.7	TX/2W OFF HOOK selection .....	5-4
5.2.8	RX 135 $\Omega$ , 150 $\Omega$ , 600 $\Omega$ , 900 $\Omega$ , 1200 $\Omega$ selections .....	5-4
5.2.9	RX OFF HOOK selection .....	5-4
5.2.10	RX TERM or BRDG selection .....	5-4
	NOTE .....	5-4
5.2.11	SEND QUIET selection .....	5-5
	NOTE .....	5-5
5.2.12	SEND SF SKIP selection .....	5-5
5.2.13	FILTER selections: .....	5-5
5.2.14	FILTER 60 Hz selection .....	5-5
5.2.15	MEASURE NTG selection .....	5-6
	NOTE .....	5-6
5.2.16	MONITOR (TX, MEAS, RX) Selections .....	5-6
5.2.17	DISPLAY (SEND, MEAS) Selections .....	5-6
5.3	LINE TERMINATION IMPEDANCES .....	5-7
	NOTE .....	5-7

5.4	TEST CONFIGURATIONS .....	5-8
	NOTE .....	5-8
5.4.1	End-to-End Testing .....	5-8
5.4.2	Loopback Testing .....	5-9
	NOTE .....	5-9
5.4.3	4-Wire Testing with Responder: .....	5-10
5.4.4	2-Wire Testing with Responder: .....	5-11
<b>SECTION 6 — MEASURE FUNCTIONS AND PARAMETERS .....</b>		<b>6-1</b>
6.1	MEASURE LEVEL AND FREQUENCY (LEVEL FREQ) .....	6-2
	NOTE .....	6-2
6.2	MEASURE LEVEL AND FREQUENCY, NARROW BAND (L/F 15 kHz or L/F UNWTD) .....	6-2
6.3	MEASURE IDLE LINE NOISE (NOISE) .....	6-2
6.3.1	Units of Noise Measurement .....	6-3
6.3.2	Test Setup for Idle Line Noise .....	6-4
6.3.3	Noise Weighting Filters: .....	6-4
6.4	MEASURE NOTCH NOISE (NOISE W/T) .....	6-4
6.4.1	Validity of Notch Noise .....	6-4
6.4.2	Test Setup for Notch Noise .....	6-4
6.4.3	Noise Weighting Filters: .....	6-5
6.5	MEASURE NOISE TO GROUND (NTG) .....	6-5
6.5.1	Noise to Ground Measurement Range .....	6-5
6.5.2	Test Setup for NTG .....	6-6
6.5.3	Noise Weighting Filters .....	6-6
6.5.4	NTG and SEND functions .....	6-6
6.6	SIGNAL-TO-NOISE RATIO (S/N RATIO) .....	6-6
6.6.1	Signal-to-Noise Ratio Measurements .....	6-7
	NOTE .....	6-7
6.6.2	Test Setup for S/N Ratio .....	6-8
6.6.3	Noise Weighting Filters: .....	6-8
6.7	IMPULSE NOISE WITHOUT TONE (IMP NOISE) or IMPULSE NOISE WITH TONE (IMP N W/T) .....	6-8
6.7.1	General Description of Impulse Noise Measurement .....	6-8
	NOTE .....	6-8
	NOTE .....	6-9
6.7.2	Impulse Noise Measurements, Parameters, and Procedure .....	6-9
	NOTE .....	6-9
6.7.3	Evaluation of Measurement Data .....	6-12
6.7.4	Test Setup for Impulse Noise without Tone .....	6-14
6.7.5	Test Setup for Impulse Noise with Tone .....	6-14
6.7.6	Noise Weighting Filters .....	6-14

<b>SECTION 7 — IEEE NOISE WEIGHTING FILTERS FOR AM5 CLASSIC</b>	<b>7-1</b>
NOTE	7-1
7.1 NOISE WEIGHTING FILTERS	7-1
7.2 60 Hz FILTER	7-8
7.3 L/F 15 kHz MEASURE FILTER	7-8
NOTE	7-8
<b>SECTION 8 — CCITT NOISE WEIGHTING FILTERS FOR AM5e CLASSIC</b>	<b>8-1</b>
NOTE	8-1
8.1 NOISE WEIGHTING FILTERS	8-1
8.2 60 Hz FILTER	8-7
8.3 L/F UNWTD MEASURE FILTER	8-7
NOTE	8-7
<b>SECTION 9 — SEND FUNCTIONS AND PARAMETERS</b>	<b>9-1</b>
9.1 NO-SIGNAL, TERMINATED (QUIET)	9-2
<b>CAUTION:</b>	<b>9-2</b>
9.1.1 QUIET Data	9-2
9.1.2 QUIET Parameters:	9-2
9.2 1004 Hz TONE (1004 Hz)	9-3
9.2.1 1004 Hz Data Display	9-4
9.2.2 1004 Hz Parameter Display / Adjustment	9-4
9.3 VARIABLE FREQUENCY GENERATOR (VAR Hz)	9-4
9.3.1 VAR Hz Data Display	9-4
9.3.2 VAR Hz Parameter Display / Adjustment	9-4
NOTE	9-4
9.4 SWEEP GENERATOR (SWEEP)	9-6
9.4.1 SWEEP Data Display	9-6
9.4.2 SWEEP Parameter Display / Adjustment	9-6
NOTE	9-6
9.5 SIGNALLING FREQUENCY SKIP (SF SKIP)	9-8
9.5.1 SF SKIP Rejection for AM5 Classic	9-8
9.5.2 SF SKIP Rejection for AM5e Classic	9-8
9.6 SINGLE FREQUENCY TONES: (F1, F2, F3, F4)	9-8
9.6.1 General Information	9-8
9.6.2 Loop Back Tone	9-9
9.7 OPEN CIRCUIT	9-9
<b>SECTION 10 — AM5 and AM5E CLASSIC SPECIFICATIONS</b>	<b>10-1</b>
<b>SECTION 11 — WARRANTY, CALIBRATION, AND SERVICE</b>	<b>11-1</b>
11.1 WARRANTY	11-1
11.2 SERVICE POLICY	11-1
11.3 CALIBRATION POLICY	11-1
11.4 RETURN OF UNIT	11-2
<b>SECTION A1 — APPENDIX</b>	<b>A1-1</b>
A.1.1 SCOPE	A1-1
A.1.2 EQUIPMENT REQUIRED	A1-1

A.1.3 CALIBRATION PROCEDURE .....	A1 – 1
A.1.4 VALIDATION PROCEDURE .....	A1 – 3
<b>INDEX</b> .....	<b>I – 1</b>

## LIST OF ILLUSTRATIONS

<b>Figure 1 — Wrong</b> (way to wind power cable) .....	<b>INSIDE OF FRONT COVER</b>
<b>Figure 2 — Correct</b> (way to wind power cable) .....	<b>INSIDE OF FRONT COVER</b>
Figure 3-1 — AM5 Classic Front Panel .....	3-2
Figure 3-2 — AM5e Classic Front Panel .....	3-2
Figure 3-3 — Level (dB/ dBm) and Noise (dBrn ) Units of Measurement .....	3-7
Figure 3-4 — AM5(e) Classic Rear Panel Drawing .....	3-16
Figure 5-1 — Line Cable Accessories for AM5(e) Classic .....	5-1
Figure 5-2 — 4-Wire Line Circuit Block Diagram .....	5-2
Figure 5-3 — 2-Wire Line Circuit Block Diagram .....	5-3
Figure 5-4 — 4-Wire End-to-End Testing Configuration .....	5-8
Figure 5-5 — 4-Wire Testing with Responder .....	5-11
Figure 5-6 — 2-Wire Testing with Responders .....	5-11
Figure 6-1 — Impulse Noise Measurement Selection/Displays .....	6-10
Figure 6-2 — Impulse Noise Parameters Selection/Display .....	6-11
Figure 6-3 — Illustration of Impulse Noise Measurement .....	6-13
Figure 7-1 — CMSG Bandwidth Filter (CMSG) .....	7-2
Figure 7-2 — Program Bandpass Filter (PGM) .....	7-3
Figure 7-3 — 3 kHz Low Pass Filter (3 kHz) .....	7-4
Figure 7-4 — 15 kHz Low Pass Filter (15 kHz) .....	7-5
Figure 7-5 — 50 Kilobit Filter (50 kBit) .....	7-6
Figure 7-6 — Wideband 120 kHz Filter (WIDE —AM5-120 Model) .....	7-7
Figure 7-7 — Wideband 160 kHz Filter (WIDE — AM5-200 Model) .....	7-7
Figure 8-1 — Psophometric Filter (PSHO) .....	8-2
Figure 8-2 — Sound Unweighted Filter (UNWTD Q-PEAK/UNWTD RMS) ....	8-3
Figure 8-3 — Sound Weighted Filter (SWTD Q-PEAK/SWTD RMS) .....	8-4
Figure 8-4 — 2 kHz Flat Filter (2 kHz FLAT) .....	8-5
Figure 8-5 — Wideband 120 kHz Filter (WIDE —AM5e-120 Model) .....	8-6
Figure 8-6 — Wideband 160 kHz Filter (WIDE — AM5e-200 Model) .....	8-6
Figure 9-1 — Send QUIET Data Display .....	9-2
Figure 9-2 — Send QUIET Parameter Displays .....	9-3
Figure 9-3 — Send 1004 Hz Data and Parameter Displays .....	9-5
Figure 9-4 — Send VARIable Hz Data and Parameter Displays .....	9-5
Figure 9-5 — Send SWEEP Data and Parameter Display .....	9-7

## 1. OVERVIEW AND UNPACKING

### 1.1 OVERVIEW

This Instruction Manual describes the operation of the Ameritec Model AM5 **Classic** and AM5e **Classic** Voice/Data Transmission Test Sets.

The AM5 **Classic** and AM5e **Classic** are microprocessor-based test instruments used to make Transmission Impairment Measurements ("TIMS") on 2- and 4-wire circuits. Models are available for IEEE Standards and CCITT Recommendations as follows:

AM5	CLASSIC-120	---	IEEE Standard 743-1984 (Bell Standard 41009)
AM5	CLASSIC-200	---	Same as AM5 Classic-120 with extended range to 200 kHz
AM5e	CLASSIC-120	---	CCITT International Recommendations
AM5e	CLASSIC-200	---	Same as AM5e Classic-120 with extended range to 200 kHz

Both the AM5 **Classic** and AM5e **Classic** are hereafter referred to as "AM5(e) **Classic**", and except where specified "AM5" or "AM5e" all information applies to both types of Classics.

The AM5(e) **Classic** also contains a separate full-function test tone generator which produces operator-selected and automatically-stepped (sweep) tones from 20 Hz to 120 kHz (or 200 kHz) required for tests.

The AM5(e) **Classic** provides five (5) impedance selections for RX and TX lines, separate DC hold circuits, and a built-in speaker monitor.

Optional features include a Signaling Adapter with Ring Generator, "Siemens"-type Line Test Connections, Rechargeable batteries for cordless portable operation, a snap-on cover, and a rack-mounting kit for permanent installations.

The 200 kHz Model of both the AM5 **Classic** and AM5e **Classic** extends the maximum frequency response measurement and generation from 120 kHz to 200 kHz.

### 1.2 UNPACKING

The AM5(e) **Classic** was thoroughly tested and carefully packed before shipment, and was in good condition when given to the carrier for shipment.

Upon receipt, thoroughly inspect the outside of the shipping container for damage. If damage is noted, immediately contact the carrier. The name of the carrier will be noted on the packing slip which is attached to the outside of the shipping container.

Open the container carefully and compare the contents with the packing slip. Note any damage or shortages. Notify the carrier in the event of damage. Notify Ameritec in the event of shortages.

Save the shipping container for future use in case the AM5(e) **Classic** must be returned to the factory.

## 2. POWER CONSIDERATIONS

### 2.1 COMMERCIAL POWER

*CAUTION: Before connecting the AM5(e) Classic to AC Power, be sure that the AC power selector switch is in the correct position. For more details refer to Section 3, sub-sections 3.3.1. and 3.4.1.*

All models of the AM5(e) Classic are powered from commercial 115 V AC or 230 V AC 50/60 Hz power, and have a power consumption of 26 Watts (VA). A rear-panel selector switch selects 115 V AC or 230 V AC.

A detachable 3-wire power cord is furnished which mates with a CCE standard V-type connector on the rear panel. The other end of the power cord has a standard three-conductor AC plug. A replaceable 1/2 Ampere fuse is also accessible on the rear panel.

### 2.2 OPTIONAL BATTERY PACK

The AM5(e) Classic may be equipped with an internal battery pack to allow for full cordless (no commercial power) operation.

The battery pack consists of two sealed lead-acid batteries and associated charging circuitry. When fully charged, the batteries will power the AM5(e) Classic for about five to eight (5-8) hours.

A low battery is indicated by blinking decimal points on the front panel display. Blinking decimal points indicate about one-half hour of remaining battery power before recharging is required.

The AM5(e) Classic may be operated while the batteries are recharging. Recharging occurs continuously whenever the AM5(e) Classic is plugged into AC power whether the power switch is turned ON or OFF. However, charging will be accomplished faster when the power switch is turned OFF. Commercial power interruption will not cause unit to stop operating as long as the batteries remain charged.

### 2.3 POWER ON AND OFF

The power ON-OFF switch is located on the upper right side of the front panel (refer to Section 3 for illustration). It is an alternate-action push button. When pushed-in, it will lock in that position and the power is ON. Push it again, the button will pop out, and the power is OFF. When the power is turned ON, the AM5(e) Classic will go through a self-test procedure, then will show factory-set test selections referred to as "defaults". The operator usually will change these settings for a particular test configuration.

The AM5(e) Classic is equipped with a non-volatile memory for test setups. Although loss of power will cause operation to cease, current test parameter settings will be stored in memory. When the AM5(e) Classic is turned back ON, these settings can be re-established instead of the defaults. A procedure for restoring these settings when power is turned ON is described in Section 4 of this Manual.

### 3. PHYSICAL AND FUNCTIONAL DESCRIPTION

This section describes the general physical characteristics of the AM5(e) Classic, the Front and Rear Panel controls, indicators, and connectors, and the optional equipment.

#### 3.1 PHYSICAL CHARACTERISTICS

- 3.1.1 Weight:** The AM5(e) Classic weighs six (6) pounds (2.7 kilograms) without the optional battery pack, and 10 pounds (4.5 kilograms) with the battery pack.
- 3.1.2 Portable Dimensions:** The AM5(e) Classic in its portable case measures 8.3 in. (210 mm) wide, 3.5 in. (89 mm) high, and 12.1 in. (307 mm) deep. With the optional snap-on cover in place, the Classic is 14 in. (356 mm) deep.
- 3.1.3 Rack Mounted Dimensions:** A 19 in. Rack Mount kit (P/N 850076) can be ordered for fixed installations. When mounted in the Rack Mount kit, the AM5(e) Classic measures 19 in (483 mm) wide, 3.5 in. (89 mm) high, and 12.1 in. (307 mm) deep. A Rack Mount kit shelf is also available (P/N 850233). For more detail refer to sub-section 3.6.5.
- 3.1.4 Construction:** The front panel (with switch and indicators labels appropriate for the AM5 Classic or AM5e Classic ) and a black, steel rear panel are attached to a sturdy aluminum case. Within the case, electronic components are mounted on three plug-in printed circuit boards, interconnected with ribbon cables. The AC power supply and optional battery pack with charging circuitry are also contained within the case.

**CAUTION:** *None of the electronic components within the case are user-serviceable, and opening the case will void the manufacturer's warranty.*

- 3.1.5 Rubber Feet:** There are four (4) rubber feet on the bottom of the case, and two rear-panel support brackets for positioning the AM5(e) Classic horizontally or vertically during operation. There are also four (4) rubber feet on the left side for setting it down after carrying it with the carrying handle.
- 3.1.6 Carrying Handle:** The carrying handle is made of thick, soft, flexible plastic. It is located on the right side of the case. It extends for use and retracts against the case when not in use.

*NOTE: Neither the rubber feet nor the carrying handle are provided when the AM5(e) Classic is installed in the 19 inch Rack Mount kit (P/N 850076).*

#### 3.2 FRONT PANEL DESCRIPTION

The front panel measures approximately 3 in. (75 mm) high by 8 in. (205 mm) wide. Both panels are illustrated in Figures 3-1 and 3-2. The panels are similar in appearance with the exception of the label nomenclature for filters, certain noise measurements, and DIAL terminal identification.



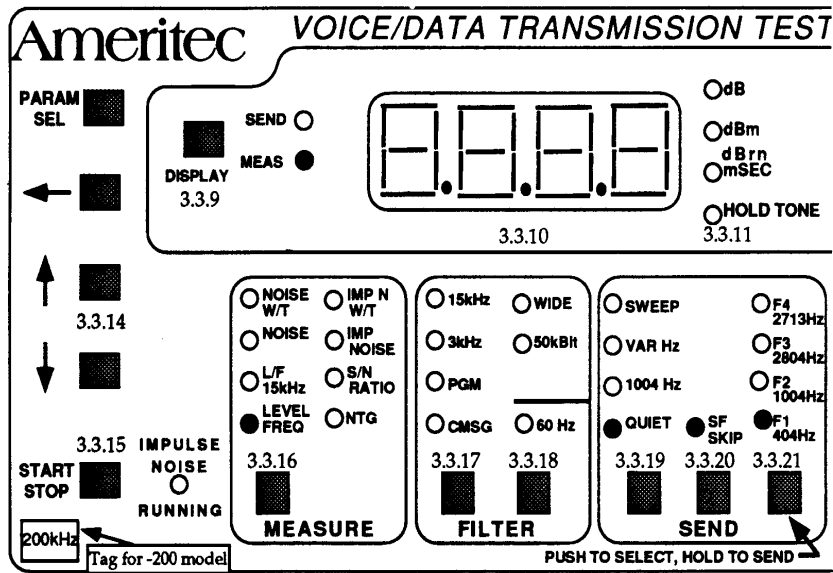

Figure 3-1 — AM5 Classic Front Panel (Sheet 1 of 2)

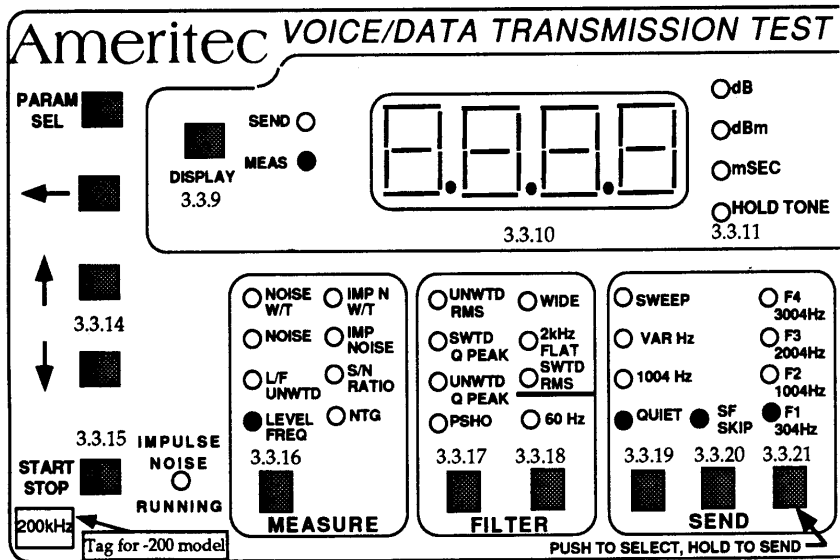

Figure 3-2 — AM5e Classic Front Panel (Sheet 1 of 2)

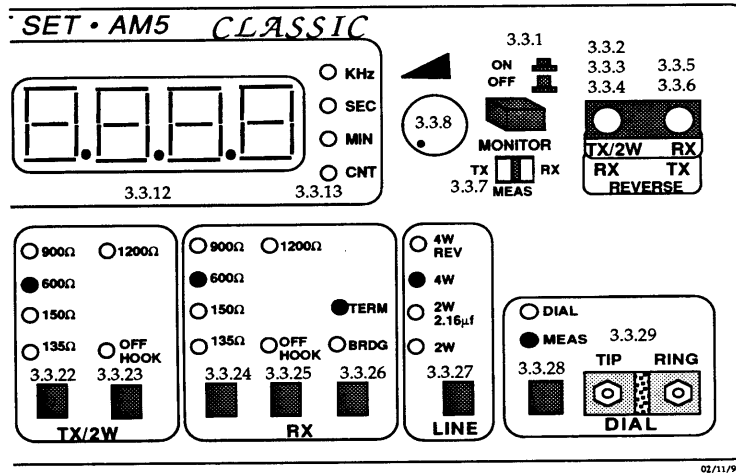

Figure 3-1 — AM5 Classic Front Panel (Sheet 2 of 2)

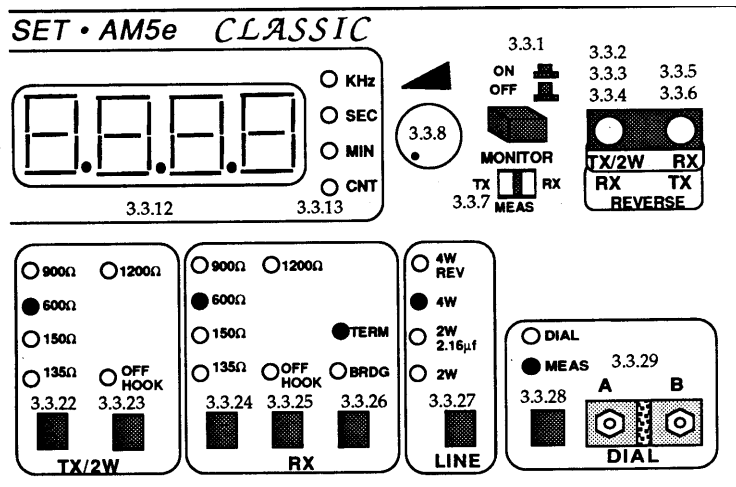

Figure 3-2 — AM5e Classic Front Panel (Sheet 2 of 2)

For the AM5(e) Classic models that have extended frequency response, the following designation plate appears on the lower-left side of the panel:

**200 kHz**

The front panel contains push-button switches, LED indicators, and LED displays for setting test conditions and displaying measurements. A speaker volume control knob is also located on the front panel. Bantam jacks are provided for line connections (duplicated on the rear panel as terminals) and two terminals are provided for a user's "Butt Set" to allow dialing and talking by the user.

All push button keys are non-membrane type, and offer good visual, tactile, and audible feedback. All indicators, including the display, are LEDs and should never need replacement.

The remaining sub-sections in Section 3 describe the controls, indicators, and displays on the front panel. The numbering of the sub-sections corresponds with the identifications of sub-sections shown on Figures 3-1 and 3-2.



Further descriptions are contained in the other Sections of this manual which describe :

- Self Test Operations Section 4
- Line Test Connections and Configurations Section 5
- Measure Functions and Parameters Section 6
- Filters for AM5 Classic Section 7
- Filters for AM5e Classic Section 8
- Send Functions and Parameters Section 9

### 3.3.1 ON OFF Button (power switch):

**CAUTION:** Before connecting the AM5(e) Classic to AC Power, be sure that the selector switch is in the correct position. For more details refer to 3.4.1.

Push the button IN to turn power ON. Push the button again and the button will pop out to turn power OFF. The front panel illustrates the power positions as shown below:

Button in		Power	ON
Button out		Power	OFF

When the power is turned ON, The Red LED indicators will come on to show the default conditions. The two display windows also may show red characters. For more information on default settings, refer to Section 4.

*NOTE: The functions selected for the TX/2W jack described in the next three sub-sections are duplicated by the T and R terminals on the rear panel.*

**3.3.2 TX/2W bantam jack for 2-wire circuits (2W LED on):** The Classic both transmits and receives signals over this jack through a built-in hybrid circuit. Connect a 2-wire circuit to this jack.

**3.3.3 TX/2W bantam jack for 4-wire circuits (4W LED on):** The Classic transmits signals over this jack. Connect the send (transmit, or TX) pair of a four-wire circuit to this jack.

**3.3.4 TX/2W bantam jack for REVERSE selection (4W REV LED on):** This jack becomes a receive (RX) jack as shown on the panel. The Classic receives signals over this jack (as described in 3.3.5). Connections are per test requirements.

*NOTE: The functions selected for the RX jack described in the next two sub-sections are duplicated by the T1 and R1 terminals on the rear panel.*

**3.3.5 RX bantam jack for 4-wire circuits (4W LED on):** The Classic receives signals over this jack. Connect the receive (or RX) pair of a four-wire circuit to this jack.

**3.3.6 RX bantam jack for 4-wire circuits for REVERSE selection (4W REV LED on):** The jack becomes a transmit (TX) jack as shown on the panel. The Classic transmits signals over this jack (as described in 3.3.3). Connections are per test requirements.

**3.3.7 MONITOR (TX, MEAS, RX) switch:** This three position switch selects the circuit point where the internal amplifier/speaker is connected:

TX(Transmit)	Connects the internal amplifier/speaker to the output of the signal generator.
MEAS (Measure)	Connects the internal amplifier/speaker to the output of the receive circuit auto-ranging amplifier and associated filters. This selection considerably increases the volume of the speaker, and is useful for monitoring low-level signals such as residual noise in NOISE WT (notched noise with tone) and SN RATIO measurements.  The signal level will always be in an 18 dB range for input signals ranging from -65 dBm to +10 dBm.
RX (Receive)	Connects the internal amplifier/speaker to the signal being measured. The possible measurements are <ul style="list-style-type: none"> <li>• Receive (RX) pair of a 4-wire circuit.</li> <li>• Two-wire (TX/2W) pair</li> <li>• Noise to Ground circuit (if measuring NTG)</li> </ul>

**3.3.8 Speaker Volume Control:** After the MONITOR switch has been used to select the monitor point, the Volume control can be turned clockwise to increase the speaker volume and counter-clockwise to decrease the volume.

*NOTE: The speaker is located at the top of the unit near the front.*

**3.3.9 DISPLAY Key:** This key selects whether the data shown in the left-hand and right-hand display windows represent test signals sent to a circuit under test (SEND) or test data measurements on the circuit under test (MEAS). Each time the key is pressed, the SEND or MEAS(ure) LED will come on to indicate which function has been selected.

**3.3.10 Left-Hand 7-Segment Display:** This is a red LED display containing four 7-segment characters with floating decimal point. These characters will indicate Levels for the SEND or MEASURE Selections in accordance with the LED indicators to the right of the display (except for Impulse Noise measurements where they identify the value being displayed in the right-hand 7-Segment Display).

After the PARAM SEL key is pressed, the characters identify a parameter that may be set in the right-hand LED display (for those functions that have parameters). Parameters for MEAS and SEND functions are described in Sections 6 and 9, respectively.

**3.3.11 Left-Hand LED's (dB, dBm, dBm, mSEC, HOLD TONE):** These LEDs provide units of measurement and other information about the current SEND or MEAS(ure) DISPLAY selection. Refer to the table on the next page:

dB	Decibel: A logarithmic (base 10) electrical unit used to compare or indicate changes in level. See Figure 3-3	Applies to: Relative level comparisons where a previously set level has been established. e.g. S/N RATIO
dBm	Decibel, based on 1 milliwatt reference: 00.0 dBm is defined as the level of one milliwatt of power. Levels of less power than this reference point are preceded by a - sign. Levels greater than this level are preceded by no sign and are assumed positive. See Figure 3-3	Applies to: SEND frequency generator levels  and  MEAS(ure) LEVEL and FREQ(uecy).
dBm	Decibel based on -90 dBm reference point: 00.0 is equivalent to -90 dBm (a very low level). This results in noise measurements that will always be positive and is typically used for noise measurements. The higher the value, the noisier the line. See Figure 3-3	Applies to noise measurements on AM5 Classic only: (the AM5e Classic shows noise in dBm).
mSEC	Millisecond: One-thousandth of a second. A display of 1000 equals one second.	Applies to: MEAS(ure) IMP NOISE (Impulse Noise) blanking interval parameter. <i>NOTE: Value is shown in right-hand 7-segment display.</i>
HOLD TONE	Indicates that 995 Hz to 1025 Hz tone (nominally 1004 Hz) is being received at RX jack. The HOLD TONE LED must be lighted for the noise with tone and S/N ratio tests to be valid. Other indicators may be lighted.	Applies to: MEAS(ure) noise measurements:  S/N RATIO, IMP N W/T, NOISE W/T (Notched Noise, S/N Ratio, and Impulse Noise with Tone.)

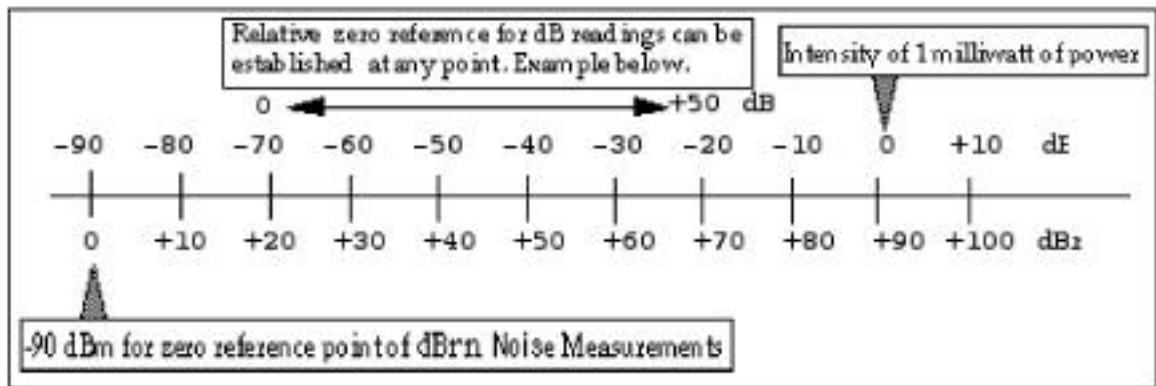

Figure 3-3 - Level (db/dbm) and Noise (dBrn) Units of measurement



**3.1.7 Right-Hand 7-Segment Display:** This is a red LED display containing four 7-segment characters with floating decimal point display. These characters will indicate values for the SEND or MEASURE frequency, time, or impulse noise count selections in accordance with the LED indicators to the right of the display (Refer to 3.3.13). When setting parameters, the numeric value of the parameter identified in the left-hand display is shown.

**3.1.8 Units of Measurement LED's (kHz, SEC, MIN, CNT):** These LEDs provide the units of measurement that apply to the data displayed in the right-hand 7-Segment Display for the SEND or MEAS(ure) DISPLAY selection.

kHz	Kilohertz: 1000 Hertz or 1000 cycles-per-second. The display for 1 kHz is 1.000.	Applies to: All FREQUENCY measurements and parameters.
SEC	Seconds: unit of time.	Applies to: SEND SWEEP Rate (time on each frequency) and Delay (dwell on beginning and end tones of sweep).
MIN	Minutes: unit of time.	Applies to: Duration parameter of IMPulse NOISE and IMPulse NOISE With/Tone.  Elapsed time measurement when either IMPulse NOISE test is RUNNING.
CNT	Counts: impulses per unit of time.	Applies to: the low, medium, and high threshold counter measurements of IMPulse NOISE and IMPulse NOISE With /Tone.

**3.1.9 PARAM SEL keys (Parameter Select and arrow keys):** The PARAM SEL key is used to step through parameters which may be pre-set for certain of the SEND or MEAS(ure) functions (Refer to Sections 6 and 9). The table that follows explains the functions of these keys.

*NOTE: The key labelled START STOP, and the LED labelled IMPULSE NOISE RUNNING are not related to parameter selection or entry (see 3.3.15)*

<p style="text-align: center;"><b>PARAM SEL</b></p> <p>Select and step through parameters, then return to data.</p>	<p>When a SEND or MEAS(ure) selection has been made that has a changeable value (parameter), press this key to display the first parameter. The parameter is identified in the left-hand display and the current value (with decimal point if applicable) is displayed in the right-hand display.</p> <p>If the value is to be changed, use the arrow keys as described below. To accept the displayed value press the key to display the next parameter or the measurement.</p> <p>If there is another parameter associated with the SEND or MEAS(ure) selection it will be displayed to be accepted or changed.</p> <p>If there is no other parameter, or the last parameter has been viewed, this key will cause the SEND or MEAS(ure) display to return to the actual data at the TX/2W or RX (4wire only) jacks.</p>																																								
<div style="display: flex; flex-direction: column; align-items: center;"> <div style="margin-bottom: 20px;">  <p>up-arrow</p> </div> <div style="margin-bottom: 20px;">  <p>down-arrow</p> </div> <p>Increase / decrease parameter values.</p> <p>Also step through Impulse Noise Measurement data (Refer to 3.3.16)</p> </div>	<p>The up and down arrows are used to increase or decrease the displayed parameter value. Each time the up-arrow is pressed, the value is increased. Each time the down-arrow is pressed the value is decreased. IF A DIGIT IS FLASHING it means that the left-arrow has been pressed to go into the <b>flashing mode</b> (continue with left-arrow description below.). The following description refers to the <b>non-flashing mode</b></p> <p>If either key is held for more than one second, the parameter will be increased or decreased for as long as the key is held down.</p> <p>The entire range of the parameter may be stepped through, in either direction, with these keys. Digits will overflow (or underflow), to increment (or decrement) the next significant digit. The increment (or decrement) may stop at the limits of the parameter range.</p> <p>The increment or decrement depends on the parameter units being set. Examples for each unit-type follow.</p> <table border="1" data-bbox="506 956 1247 1236"> <thead> <tr> <th>Parameter</th> <th>Display</th> <th>Unit</th> <th>momentary</th> <th>hold (two/second)</th> </tr> </thead> <tbody> <tr> <td>Level</td> <td>LEVL</td> <td>dBm</td> <td>.1</td> <td>1.</td> </tr> <tr> <td>Frequency</td> <td>FREQ</td> <td>kHz</td> <td colspan="2">(see sub-section 9.3.2)</td> </tr> <tr> <td>Impulse Noise</td> <td></td> <td>dBm</td> <td>.1</td> <td>1</td> </tr> <tr> <td>Threshold</td> <td>iTHd</td> <td>dBm</td> <td colspan="2">(on AM5e only)</td> </tr> <tr> <td>Blanking</td> <td>bLnC</td> <td>mSEC</td> <td>1</td> <td>10</td> </tr> <tr> <td>Rate</td> <td>rATE</td> <td>SEC</td> <td>.1</td> <td>1</td> </tr> <tr> <td>Duration</td> <td>dur</td> <td>MIN</td> <td>.1</td> <td>1</td> </tr> </tbody> </table>	Parameter	Display	Unit	momentary	hold (two/second)	Level	LEVL	dBm	.1	1.	Frequency	FREQ	kHz	(see sub-section 9.3.2)		Impulse Noise		dBm	.1	1	Threshold	iTHd	dBm	(on AM5e only)		Blanking	bLnC	mSEC	1	10	Rate	rATE	SEC	.1	1	Duration	dur	MIN	.1	1
Parameter	Display	Unit	momentary	hold (two/second)																																					
Level	LEVL	dBm	.1	1.																																					
Frequency	FREQ	kHz	(see sub-section 9.3.2)																																						
Impulse Noise		dBm	.1	1																																					
Threshold	iTHd	dBm	(on AM5e only)																																						
Blanking	bLnC	mSEC	1	10																																					
Rate	rATE	SEC	.1	1																																					
Duration	dur	MIN	.1	1																																					
<div style="display: flex; align-items: center;">  <p>left-arrow</p> </div> <p>Selects flashing mode. Then selects digit and decimal point. Finally returns to non-flashing mode.</p>	<p>The left-arrow is used to turn on the <b>flashing mode</b>. This mode is used to set individual digits of parameters which have a wide range of values (for example frequency range of 20 Hz to 200 kHz). When a value is displayed and this key is pressed, the <b>least significant digit</b> will flash. Each press of the up or down arrow keys will increase or decrease the value of that digit by one.</p> <p>Each press of the left-arrow key moves the flashing digit to the left by one digit. After the most significant digit is reached, the next press will turn off the flashing-digit mode.</p> <p>If a decimal point is encountered, it will flash. The up- and down-arrow keys will then move the decimal point one digit to the right or left, respectively.</p> <p>After the left-most digit has been reached, another press returns to <b>non-flashing mode</b>.</p>																																								



**3.3.15 START/STOP Key (Impulse Noise Measurement):** This key is pressed to start Impulse Noise measurements after IMP NOISE has been selected in the MEASURE area of the panel. (see 3.3.16).

When Impulse Noise measurements are running the IMPULSE NOISE RUNNING indicator beside the switch flashes. Impulse Noise measurements may be set (through parameters) to have a time duration, so after the test is started it will stop after the time has elapsed. To stop Impulse Noise measurements while the indicator is flashing, press the START/STOP key again. Refer to Section 6 for a description of Impulse Noise measurement.

**3.1.10 MEASURE Key:** Eight types of measurement may be selected by this key. Selection is by rotation and is indicated by the lighting of the LED adjacent to the abbreviation for the measurement. Measurements are always made from a signal source coming into the AM5(e) Classic (RX for 4-wire lines, or TX/2W for 2-wire lines). The following table identifies the measurements, indicates units of measurement, and whether there are parameters. MEASURE functions and parameters are described in Section 6.

Measurement	Units of Measurement		Parameters	
LEVEL	dBm		no	
FREQ (uency)	kHz			
L/F 15 kHz (AM5)	dBm		no	
L/F UNWTD (AM5e)	kHz (below 15.00) kHz (0.030 - 20.00)			
NOISE	dBm (AM5) dbm (AM5e) kHz		no	
NOISE W/T (Noise With/Tone)	dBm (AM5) dbm (AM5e) kHz		no	
NTG (Noise to Ground)	dBm (AM5) dBm (AM5e)		no <i>("NTG-" appears in right display if not in SEND QUIET mode)</i>	
S/N RATIO	dB		no	
IMP (Impulse) NOISE <i>(Impulse noise measurements are selected by up- and down- arrow keys after Time is displayed)</i>	Time	MINutes	dur	MIN
	Nois	CNT	iTHd:	dBm or dBm
	iLo		idLT:	dB
	iMid		bLnC:	mSEC
iHi				
IMP N (Impulse Noise W/T with Tone)	same as above		same as above	
<i>Impulse noise measurements and parameters are abbreviated to resemble the display.</i>				

**3.3.17 FILTER (left key):** This key can select six filters and RMS detection for use with the MEASURE NOISE functions of an AM5 Classic (as shown in Figure 3-1) and five filters and RMS or Quasi-Peak detectors for an AM5e Classic (shown in Figure 3-2). Filters are selected in rotation each time the key is pressed, and the selection is indicated by the lighting of the LED adjacent to the abbreviation for the measurement.

For the AM5 Classic the selections are:

- **CMSG** (C-Message Bandpass)
- **PGM** (Program Bandpass)
- **3 KHz** (3 kHz flat)
- **15kHz** (15 kHz flat)
- **50kBit** (Low Pass and High Pass)
- **WIDE** (20 Hz to 120 kHz) for standard units or (20 Hz to 160 kHz) for **200 kHz** units

For the AM5e Classic the selections are:

- **PSHO** (Psophometric Bandpass)
- **UNWTD Q PEAK** (Sound Unweighted Quasi-Peak detection)
- **SWTD Q PEAK** (Sound Weighted Quasi-Peak detection)
- **UNWTD RMS** (Sound Unweighted RMS detection)
- **SWTD RMS** (Sound Weighted RMS detection)
- **2kHz FLAT** (2 kHz flat)
- **WIDE** (20 Hz to 120 kHz) for standard units or (20 Hz to 160 kHz) for **200 kHz** units

*NOTE: When MEASURE selection is LEVEL/FREQ or L/F 15 kHz on an AM5 Classic (LEVEL/FREQ or L/F UNWTD for AM5e Classic), none of the above filters can be selected. However, the L/F 15 kHz (L/F UNWTD) selection places a low pass filter into the measurement circuits to eliminate high frequencies which are not of interest or when high-frequency signals (in addition to Voice Frequencies) on the line could give false readings. Filters are described in detail in Section 7 for the AM5 Classic, and in Section 8 for the AM5e Classic.*

**3.3.18 FILTER (right key):** This key selects a 60 Hz filter; the 60 Hz LED is lighted when the filter is selected. The 60 Hz filter can be selected in addition to any other filters, and is useful when making measurements on circuits that have power-line interference. This filter cuts off frequencies below 60 Hz, and so also applies to 50 Hz or 25 Hz power-line interference. If the LEVEL or FREQUENCY measurement display is not steady, there may be an improvement when this function is ON.

- OFF (LED not lighted) is the default.

**3.3.19 SEND (left key):** This key allows the user to select and activate, in rotation,

- QUIET no output
- 1004 Hz steady tone
- VAR Hz Variable frequency tone (manually adjustable over the entire frequency range of the generator)
- SWEEP Sweep frequency generator which may be adjusted by parameters for lower limit (STrT), upper limit (SToP), frequency increment (STEP), time on each frequency (rATE) and dwell time on the first and last frequencies (dLAY).

When a new function is selected, the LED is lighted immediately, the previously selected SEND function stops, and the new function starts.

- QUIET is the default.

**3.3.20 SEND (middle key):** The middle key activates SF SKIP, and the LED is lighted when this function is turned ON. SF skip prevents any tones from being sent in the SF signaling range (2450 - 2750 Hz for AM5 Classic; 2130 - 2430 Hz for AM5e Classic). This skip prevents interference with other equipment while making tests.

- ON (SF SKIP lighted) is the default.

**3.3.21 SEND (right key):** This key selects and sends one of four frequencies (each of which may be manually adjusted from the nominal frequencies stamped on the panel by parameters).

To select a frequency, press the key momentarily (less than one second) to step, in rotation, from F1 to F4. The LED adjacent to the frequency flashes on and off at 1/2 second intervals to show the frequency is selected.

To send the frequency, press and hold the key for approximately three seconds until the LED goes steady, then release the key. The tone will be sent until the key is pressed again (for less than one second), or if a frequency is selected from the SEND (left key) function.

The single-tone over-rides any other SEND function. If a SWEEP frequency is being generated, the SWEEP is reset to its starting frequency after the tone is stopped.

The single-tone may also be over-ridden by pressing any of the left SEND keys. For example, if an F4 tone is being output, shifting from QUIET to 1004 Hz will automatically stop the F4 tone and send the 1004 Hz tone.

- F1 is the default.

*NOTE: Send Functions and Parameters are described in Section 9.*

**3.3.22 TX/2W (left key):** This key selects, in rotation, the impedance of the output of the AM5(e) Classic SEND functions at the TX/2W jack (and rear-panel T and R terminals) when the LINE selector (3.3.27) is set for any position but 4W REVERSE.

When in the LINE selector is in 4W REVERSE position, the selected impedance is for output at the TX REVERSE jack (and rear-panel T1 and R1 terminals).

- 600 ohm is the default.

**3.3.23 TX/2W (right key):** This key is an alternate-action key which connects a holding coil equivalent (DC path of about 200  $\Omega$ ) to the TX/2W circuit while maintaining an AC impedance of greater than 50 K  $\Omega$ . When OFF HOOK, the holding coil is across the TX/2W tip and ring terminals. When ON HOOK, the holding coil is disconnected.

- ON HOOK (OFF HOOK not lighted) is the default.

**3.3.24 RX (left key):** This key selects, in rotation, the impedance of the input of the AM5(e) Classic for MEASURE functions at the RX (and rear-panel T1 and R1 terminals) when the LINE selector (3.3.27) is set to 4W.

When the LINE selector is in 4W REVERSE position, the selected impedance is for input at the RX REVERSE jack (and rear-panel T and R terminals).

When the LINE selector is in either 2W position, the measure section presents high-impedance ( $> 50 K \Omega$ ) to the TX/2W jack.

- 600 ohm is the default.

The TERMINATING function must be active for any impedance setting to apply (see sub-section 3.3.26).

**3.3.25 RX (middle key):** This key is an alternate-action key which connects a holding coil equivalent (DC path of about 200  $\Omega$ ) to the RX circuit while maintaining an AC impedance of greater than 50 K  $\Omega$ . When OFF HOOK, the holding coil is across the RX tip and ring terminals. When ON HOOK, the holding coil is disconnected.

- ON HOOK (OFF HOOK not lighted) is the default.

**3.3.26 RX right key):** This key selects, in rotation, a termination with the selected impedance (TERMINATE lighted) or a high-impedance ( $> 50 K \Omega$ ) bridging impedance (BRDG lighted). This key has no effect on RX functions when the LINE selector is in a 2W position.

- TERMINATE is the default.

**3.3.27 LINE Key:** This key selects, in rotation, the line connections for the TX/2W and RX jacks. Selections are shown in the following table. Descriptions of the physical connections to the jacks are provided in Section 5.

LINE Selection	Function to TX/2W jack (Rear-Panel T and R)	Function to RX jack (Rear-Panel T1 and R1)
2W	SEND at TX/2W impedance selected. MEASURE at > 50 K $\Omega$	NONE
2W 2.16 $\mu$ F	Same as above but with series capacitance of 2.16 $\mu$ F between jack and resistive termination of SEND circuitry. The capacitance causes a low-frequency roll-off that simulates a typical end-instrument. Used with SEND QUIET mode for Return Loss measurements from the distant end of a circuit.	NONE
4W (default setting)	SEND at TX/2W impedance selected.	MEASURE at RX impedance selected, if RX TERMination is ON. If RX BRDG is ON, impedance is > 50 K $\Omega$
4W REV	MEASURE at RX impedance selected, if RX TERMination is ON. If RX BRDG is ON, impedance is > 50 K $\Omega$ .	SEND at TX/2W impedance selected.

**3.3.28 DIAL key:** This key selects, in rotation, the DIAL and MEAS(ure) functions. When DIAL is selected, the TX/2W jack is directly connected to the DIAL terminals on the front panel and all internal AM5(e) Classic circuitry is disconnected.

When MEAS(ure) is selected, the DIAL terminals are disconnected and the internal AM5(e) Classic circuitry is connected.

- MEAS(ure) is the default.

**3.3.29 DIAL Terminals:** The DIAL terminals permit you to connect a Lineman's Handset (also called a "butt set") to the terminals labelled "TIP" and "RING" on the AM5 Classic or "A" and "B" on the AM5(e) Classic.

When the DIAL function has been selected, you can use the Lineman's Handset to dial out on the TX/2W connection (either DTMF or MF) to access a test line, responder, or other location. For pulse dialing, you must set the unit to either 4W (or 4W REVerse with change to the RX connection). This applies to units with software version 103A and before (refer to 4.6.3, step 3, to determine software used in the unit.).

After the connection is established, select MEAS(ure) to conduct the test.

### 3.4 REAR PANEL

The rear panel of the AM5(e) Classic is shown in Figure 3-4. The AC power supply assembly is mounted on the right side of the rear panel. It has a CCE standard V-type connector for the power cord, a fuse holder for the replaceable 1/2 Ampere fuse, and a selector switch for 115 V AC or 230 V AC operation.

**CAUTION:** *Before connecting the Classic to AC Power be sure that the AC Power selector switch is in the correct position. For more details refer to 3.4.1.*

There are five terminals on the lower left side of the rear panel for “permanent” connections to a line (especially when the AM5(e) Classic is rack mounted).

*NOTE: the REVERSE switch on the front panel reverses the functions of both the front-panel jacks and the rear-panel terminals.*

**3.4.1 AC Power Selector Switch:** This is a red slide switch that is located on the top of the Power supply. It is used to select between 115 Volt and 230 Volt operation. Before plugging in the power cord, set this switch to match the power source to which the power cord is to be connected.

**CAUTION:** *Observe the CAUTION notice printed on the back of the AM5(e) Classic. When planning to connect the power cord to a 230 volt AC source, be sure to set this switch to the 230 V position before turning on the power switch. Damage to the unit will result if 230 V AC is applied with this switch set to 115 V AC.*

**3.4.2 Fuse Holder:** This holder has a slotted cover which can be unscrewed with a common blade screwdriver so the fuse may be inspected/replaced. The fuse is 1/2 Ampere 250 V.

**3.4.3 Power Plug:** This is a 3-pronged male CCE plug for 115V or 230V AC operation. The mating power cord is supplied. Be sure AC Power Selector switch (3.4.1) is in the correct position.

**3.4.4 Identification Label:** This label is attached to the rear of the power supply. The six-digit Serial Number is coded as follows:

- First two digits:        00 - 52        Week of manufacture
- Second two digits:     00 - 99        Year of manufacture
- Third two digits:       00 - 99        Identification number

For example: Serial Numbers 519207 and 519211 are for two different units built in the 51st week of 1992, while 529212 would be for a unit built in the 52nd week.

- 3.4.5 **Screw Terminal, Ground:** This is the same connection as the Sleeve contacts on the front-panel bantam jacks. Ground (connected at either location) is required for the reference in the NTG (Noise to Ground) Test. (NTG test is described in Section 6.)
- 3.4.6 **Screw Terminals, T1 and R1:** These are the same connections as the Tip and Ring of the right front-panel bantam jack (RX).
- 3.4.7 **Screw Terminals, T and R:** These are the same connections as the Tip and Ring of the left front-panel bantam jack (TX/2W).

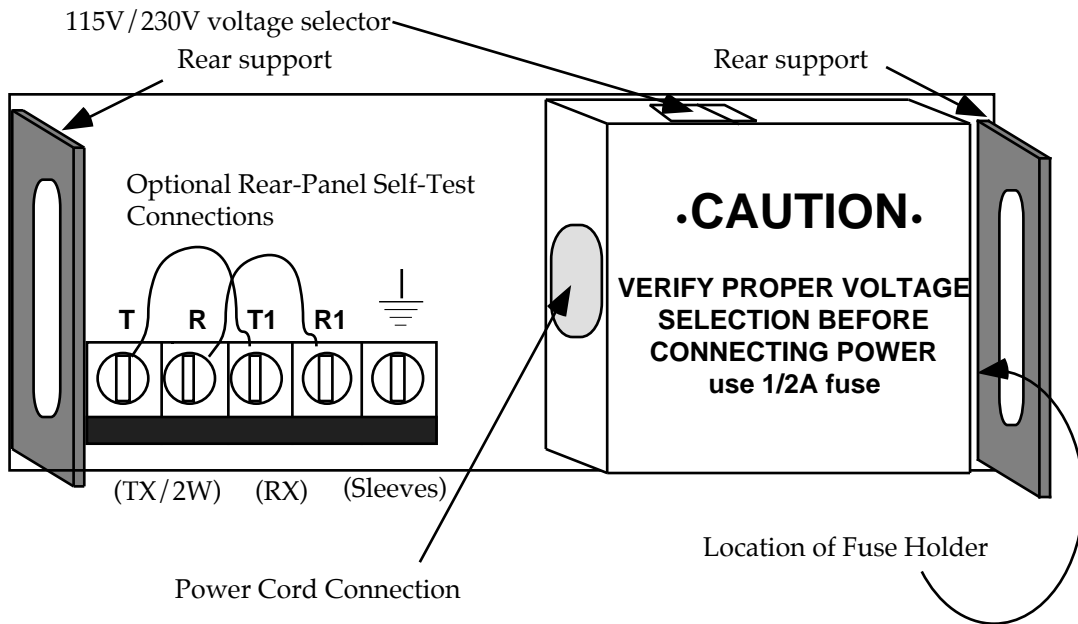

Figure 3-4 — AM5(e) Classic Rear Panel Drawing

### 3.5 OPTIONAL FACTORY-INSTALLED EQUIPMENT

This sub-section describes the features that must be ordered for the AM5(e) Classic before shipment. Other accessories that can be ordered at any time are described in sub-section 3.6.

- 3.5.1 Sealed Lead-Acid Batteries and Integral Charger (Option 24-0017):** These batteries are located inside the case and provide five to eight hours of operation without any external power connection. The charger permits the batteries to be charged while the unit is in operation or turned OFF. The battery pack adds approximately four pounds (1.8 kg) to the weight of the AM5(e) Classic .
- 3.5.2 Siemens type “banana” input adapter for AM5e Classic only (Option 25-0041):** The “banana” input adapter brings the line connections to two in-line socket connectors that are designed to mate with lines that are connected with a 3-pronged Siemens-type Banana connector. This is a standard in some European countries. The adapter is mounted on the bottom of the AM5e Classic , flush with the front panel. Refer to the front cover of this manual for a view of this unit mounted underneath the AM5e Classic.

- 3.5.3 Model 30-0033XT Signaling Adapter with Ring Generator:** This is an adapter unit which is attached to the clips on the left- and right-front sides of the AM5(e) Classic .

The Signaling Adapter provides Loop Start, Ground Start, DID, and Types I, II, and III E & M signaling. The adapter also incorporates a ring generator with manual cadence selection and automatic ring trip.

The adapter supplies both 24 and 48 Volt DC loop supply voltage with a switch to allow for simulation of a 1240 ohm loop resistance.

LED indicators are provided to indicate signaling status.

Bantam connectors are used for access to E & M, SB/SG, Line Tip and Ring, and the connection to the AM5(e) Classic.

The Signaling Adapter is separately powered by 115 Volts AC.

For more information refer to the "AM5XT Signaling Adapter Models 30-0033 and 30-0033XT Instruction Manuals" (P/N 180023) or contact Ameritec Corporation Sales Representative.

*Note: "Adapter" is alternate spelling on front panel of this particular unit.*



### 3.6 ACCESSORIES

This sub-section describes the accessories for the AM5(e) Classic . These items are not automatically supplied with the AM5(e) Classic . They must be added to the order by customer request; however, they can be added in the field if desired.

**3.6.1 Line Cables:** Three types of Line Cables may be ordered for a front-panel line connection to the bantam jacks (TX/2W and RX). The cables are six-feet in length and differ in the terminations to the equipment. Cables are as follows (two must be ordered for four-wire operation):

- 48-0047      Bantam (M) to Bantam (M) Input Cable
- 48-0048      Bantam (M) to 310 (M) Input Cable
- 48-0062      Bantam (M) to mini-clip Input Cable

Refer to Section 5, Line Connections, for illustrations.

**3.6.2 Protective front panel (85-0078):** This is a plastic cover which is designed to fit over the front panel of the AM5(e) Classic . It clips to the slots on either side of the front panel bezel and protects the front panel from damage.

*Note : This cover is not needed if the Model 30-0033XT Signaling Adapter option is ordered.*

**3.6.3 Padded Carrying Case (87-0070):** This case is intended to protect and carry the AM5(e) Classic to field-testing locations. The AM5(e) Classic can be operated without removing it from the case. The case is constructed of padded green/grey heavy canvas and has pouches to hold Instruction Manual, Cables, small tools, and other items.

**3.6.4 19" Rack Mounting Kits (85-0076):** This kit (usually ordered before shipment) provides the brackets for permanent mounting of an AM5(e) Classic in a standard 19 inch rack. Mounting feet and carrying handle are not installed on the AM5(e) Case when this item is ordered.

**3.6.5 19" Rack Mounting Shelf (85-0233):** This shelf is similar in purpose to the Rack Mounting Kit. However, it is specifically designed to be used with an AM5e Classic with the Siemens-type "banana" input adapter.

(END OF SECTION 3)

## 4. SELF TEST AND CALIBRATION

This section describes procedures to verify that the AM5(e) Classic is working properly. It also identifies the “factory default” settings and provides a calibration procedure.

### 4.1 SELF TEST CONFIGURATION

Self tests are performed with the AM5(e) Classic looped back on itself and not connected to any external equipment.

Signals sent through the transmit (TX/2W) jack are routed directly back to the Receive (RX) jack through a Bantam Cable (48-0047) plugged into these jacks. If this cable is not available, a pair of wires may be connected to the rear panel screw terminals (T to T1 and R to R1).

### 4.2 POWER ON SELF-TEST

To begin a self-test, press the POWER switch in (it will lock). All LEDs will light, all segments and decimal points will light in the display (“all 8s”), then the words TEST PASS will be displayed on the display windows on the front panel. These displays will last for about three (3) seconds. The AM5(e) will then assume its default configuration.

*NOTE: If the message “Full Cal ?” appears, it indicates that the user should perform a calibration check for absolute assurance that the unit will measure within specifications. This indication should not appear during power turn-on except at the factory.*

### 4.3 DEFAULT SETTINGS

**4.3.1 Function LEDs at Power Turn-on:** The following LEDs will be lighted after the “all 8s” and TEST PASS message has been displayed. These are the “factory default” settings which place the AM5(e) Classic in its basic mode of operation. Refer to Figure 3-1 or 3-2 for the locations of the indicators. The following is a list of LEDs that will be lighted (starting with DISPLAY MEAS and moving counter-clockwise on the front panel):

Function	LED
DISPLAY	MEAS
MEASURE	LEVEL FREQ
SEND	QUIET, SF SKIP, and F1 (flashing)
TX/2W	600
RX	600 and TERM
LINE	4W
DIAL	MEAS

**4.3.2 Parameter Settings at Power Turn-on:** Many of the functions have parameters that may be changed for a specific test setup. More detail on the settings of parameters and measurements are described in Sections 6 and 9 that describe MEASURE and SEND, respectively. A brief summary follows (Value Range column shows the minimum <default> and maximum values for parameters):

Function key	Function LED	Meas*/Parameter	Value Range
MEASURE  Use up and down arrow keys to step through measurements.  Use PARAM SEL key to step through parameters.	IMP N W/T (Impulse Noise with tone) or IMP NOISE (without tone) *Note: Time, impulse counters, and noise are measurements listed in order of display as up arrow key is pressed).	TiME	0.0 MINutes
		iHi (High,	0 CNT
		iMid Middle,	0 CNT
		iLo Low Impulse Counters)	0 CNT (Above data depend on last test)
		noiS (Noise)	uNdr
		dur (duration)	000.1 <015.0> 999.9 MINutes
		iTHd (Impulse Threshold)	20.0 <68.0> 110.0 dBrn (AM5) or -70 <-22> +20 dBm (AM5e)
		idLT (Impulse Delta)	2, 3, <4>, 6 dB
SEND	QUIET NOTE: Any LEVL setting affects all SEND levels. All Frequency ranges are 0.020 through 120.0 kHz (or 200.0 kHz). See Value Range column defaults	LEVL (all SEND Levels)	-50.0 <00.0> 13.0 dBm
		F1	AM5 [AM5e] 0.404 [0.304] kHz
		F2	1.004 [1.004] kHz
		F3	2.804 [2.004] kHz
		F4	2.713 [3.004] kHz
		VERsion (typical)	101A
SEND	1004 Hz	LEVL FrEQuency	(all SEND) 1.004 kHz
SEND	VAR Hz	LEVL FrEQuency	(all SEND) 1.004 kHz
		LEVL	(all SEND)
SEND	SWEEP	STrT Frequency	0.304 kHz
		SToP Frequency	3.004 kHz
		STEP Size	0.100 kHz
		rATE	000.1 <003.0> 999.9 SECOnds
		dLAY (delay)	<000.0> 999.9 SEC

2. Press the DISPLAY key so that MEAS is lighted to measure the signal from the equipment or line under test.  
*or*  
Press the DISPLAY key so that SEND is lighted to display the output of the signal generator to the equipment or line under test.

3. Except for IMPulse NOISE measurements, the left display will be a level in dB, dBm, or dBm (AM5 Classic only). The right display will be a frequency in kHz.

*NOTE: If the level is too low (or nothing is connected) "UndR" will be displayed in the left window, and the right window will be blank..*

4. Press the PARAM SEL key once
5. The first parameter will be displayed. The left window will identify the parameter, and the right window will show the value. One of the LEDs beside the displays will be lighted to show the units.
6. Press the PARAM SEL key again. If there is another parameter, it will be displayed. Otherwise; the unit will return to displaying the SEND or MEAS function.

**4.3.3 Restoring Previous Settings:** Whenever the AM5(e) Classic is turned OFF, the current test settings are stored in its memory. When the unit is turned back ON the default settings are restored. If the operator wants to return to the settings just before the power was turned off, follow this procedure:

1. Press the SEND key until QUIET is lighted.
2. Press the DISPLAY key so SEND is lighted.
3. Hold the  key for more than one (1) second.
4. The display will give the power down? parameters prompt.
5. Press the PARAM SEL key to recall all configuration settings and parameters before the last power down.

*NOTE: To escape from the sequence, press the SEND key instead of PARAM SEL/ETR.*

6. After parameters have been reset, set the desired configuration for tests and continue operations.



## 4.5 LOOPBACK TESTS

This sub-section contains some basic procedures for verifying the operation of the AM5(e) Classic. In these procedures, those steps identified as “(df)” do not have to be performed if the factory defaults are in effect, as indicated by the LED display described in the step. If a different display is shown on the panel, or you want to verify the operation of the key, then perform the step. **Press keys momentarily for less than 1 second, until LED indication occurs, unless otherwise directed.**

### 4.5.1 Set up

1. If not already on, turn on the AM5(e) by pressing the power switch to the ON (locked-in) position. Observe all lighted LEDs, “8.8.8.8 8.8.8.8” then “TEST PASS” display, then default configuration (see 4.5.2).
2. Verify that there is a bantam cord connected between the TX/2W jack and the RX jack, or (alternatively) there is a T  $\longleftrightarrow$  T1 and R  $\longleftrightarrow$  R1 connection at the rear-panel terminals.

**4.5.2 QUIET Test:** This test checks the AM5(e) Classic default settings, and verifies QUIET mode displays.

1. (df) Press DISPLAY key until MEAS is lighted.
2. (df) Press MEASURE key until LEVEL FREQ is lighted.
3. Press MEASURE key until NOISE is lighted. Verify that FILTER CMSG (PSHO on AM5e) is lighted, then continue to press MEASURE until LEVEL FREQ is lighted again.  
(df) Press right FILTER key until 60 Hz is not lighted.
4. (df) Press left SEND key until QUIET is lighted.  
Press middle SEND key until SF SKIP is not lighted.  
(df) Press right SEND key until F1 404Hz (F1 304 on AM5e) is flashing.
5. (df) Press left TX/2W key until 600 $\Omega$  is lighted.  
(df) Press right TX/2W key until OFF HOOK is not lighted.
6. (df) Press left RX key until 600 $\Omega$  is lighted.  
(df) Press middle RX key until OFF HOOK is not lighted.  
(df) Press right RX key until TERM is lighted.
7. (df) Press LINE key until 4W is lighted.
8. (df) Press DIAL key until MEAS is lighted.

9. Observe indication on display:
  - Left display reads "Undr" with dBm lighted.
  - Right display is blank, and no LED is lighted.
10. Press DISPLAY key until SEND is lighted and observe
  - Dashes are displayed in both displays and no LEDs are lighted.
11. Press PARAM SEL key repeatedly and observe that the displays step through the SEND QUIET parameters (LEVL, F1, F2, F3, F4 and VER as shown in the parameters table under 4.5.1). Stop when the display of step 10 is again reached.
12. Set MONITOR switch to the TX position and turn the volume control all the way counter-clockwise, then turn back about 1/8 turn.
13. Press the right SEND key briefly until F2 is flashing. Then hold key for over three seconds (then release) until readings below are checked. Press the key again briefly to stop the tone when done.
  - F2 is lighted, steady.
  - Left display reads 00.0 with dBm lighted.
  - Right display reads 1.004 with kHz lighted.
  - Tone is heard from speaker (stops when key is released)
  - Displays go back to those of step 10 (when key is released).
14. Press MEASURE key until NOISE is lighted.
15. Press DISPLAY key until MEAS is lighted.
  - Left display reads "undr" with dBm lighted (dBm on AM5e Classic)
  - Right display is blank and no LEDs are lighted.
16. Set the MONITOR switch to the MEAS position, and turn volume control knob clockwise slowly until any sound from speaker is at a comfortable level. The most that should be heard is hiss from the internal electronics of the AM5(e) Classic since SEND is set to QUIET. Turn volume control back to about 1/8 turn from full counter-clockwise limit before starting the next test.

*NOTE: When the MONITOR switch is set to MEAS position, the speaker is connected to an automatic-gain-controlled amplifier used in the NOISE and auto-ranging features. Even though no signal is connected to the RX jacks, there will be feed through of tones from the SEND function. If the signal is looped back, the amplifier will compensate for the input, and the tone will sound about the same as it will when MONITOR switch is in the TX or RX position.*

**4.5.3 SEND 1004 Hz Test:** This test activates 1.004 kHz continuous test tone, checks MEASURE functions, and verifies operation of HOLD TONE indicator and notch filter for noise tests. Unless otherwise indicated, a test cable must be connected from TX/2W jack to the RX jack (or between rear terminals).

1. Set MONITOR switch to the TX position and turn volume control to about 1/8 turn clockwise (from full counter-clockwise).
2. Press the left SEND key until 1004 Hz is lighted.
  - Tone will be heard from speaker.
3. Press MEASURE until LEVEL FREQ is lighted.
4. Press DISPLAY until SEND is lighted
  - Left display will read  $00.0 \pm 1$  (1.0 through -1.0) with dBm lighted.
  - Right display will read  $1.004 \pm .002$  (1.002 through 1.006) with kHz lighted.
5. Press DISPLAY until MEAS is lighted.
  - Displays will read the same as step 4 (assumes TX/2W jack is connected to RX jack).
6. Set MONITOR switch to RX position.
  - Tone will be heard from speaker
7. Press MEASURE key until NOISE is lighted
  - For AM5 Classic — Left display will read  $90.0 \pm 1.0$  with dBm lighted.
  - For AM5e Classic – Left display will read  $00.0 \pm 1.0$  with dBm lighted.
  - Right display will be blank. (Frequency measurement is disabled during NOISE measurement.)
8. Press MEASURE key until NOISE W/T (Noise with Tone) is lighted.
  - Green HOLD TONE LED will be lighted beside left display.
  - For AM5 — Left display will read less than 40.0 with dBm lighted.
  - For AM5e – Left display will read less than -50.0 with dBm lighted.
  - Right display will read 1.004 kHz
  - Tone will be heard from speaker. (Tone will be fainter if MONITOR switch is set to the MEAS position.)

*NOTE: NOISE with Tone incorporates a sharply-tuned notch filter at 1.004 kHz. This filter keeps the HOLD tone from the measuring circuits. In some cases, this level will be low enough that "undr" is shown in the left display. In this case, the right display will be blank.*

9. Press MEASURE key until S/N RATIO is lighted.
  - Green HOLD TONE LED will be lighted beside left display.
  - Left display will read greater than 50.0 or "oVEr" with dB lighted (this indicates a very quiet "line").
  - Right display will read  $1.004 \pm .002$  with kHz lighted.
10. Disconnect test connections from TX/2W to RX. Turn off power then turn it back on to re-establish the default settings.

*NOTE: If a problem is found in any of the checkouts or the Calibration Procedure contact Ameritex Customer service. See Section 11, Warranty.*

#### 4.6 CALIBRATION PROCEDURE

The AM5(e) Classic was calibrated at the Factory for proper measurement accuracy by loading preset values into its internal RAM. RAM is maintained by a small internal battery.

During the power-on self-test, the unit will automatically diagnose itself and, if necessary, provide a display to inform the operator of the need for recalibration.

- 4.6.1 External Test Equipment:** A high-accuracy digital voltmeter must be used to calibrate the AM5(e) Classic. The voltmeter must measure AC volts RMS, and be accurate at 1000 Hz within .4%. Minimum input impedance of the voltmeter should be 200 k $\Omega$ .

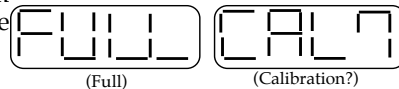

A test cable such as the 48-0062 (Refer to Section 5) may be used to connect the voltmeter leads to the front panel jack.

#### 4.6.2 Calibration Setup

1. Disconnect all self-test or other input or output connections at the AM5(e) front panel or at the rear panel.
2. Connect leads of the voltmeter to RX Jack at the front panel (using test cable) or make the connection at the T1 and R1 terminals at the rear panel.



**4.6.3 Calibration Procedure:** This procedure may be performed at any time to bring up the calibration function. If power has just been turned on, the display at step 4 will already have appeared.

1. Press the SEND key until QUIET is lighted.

2. (df) Press the DISPLAY key so that SEND is lighted.

3. Press PARAM SEL/ETR key repeatedly to step through the QUIET parameter list. Stop at the Version display.

(Version)

(101A - typical)

4. Hold the START/STOP key (adjacent to IMP NOISE RUNNING LED) for more than one (1) second until the full calibration prompt is displayed.

(Full)

(Calibration?)

5. To skip the calibration, press SEND key (QUIET will remain lighted).

or











To go into the full calibration mode of operation, press the ← key. Selections will go to the defaults, the 1004Hz LED (and tone) will come on, and the display will prompt for the high calibration (V1).

6. Check the reading on the external voltmeter. The 1.900 display represents the expected AC RMS value, the actual reading on the voltmeter varies from unit to unit. If the display is greater than 1.900, turn the power OFF and restart calibration.

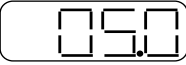
7. Use the ↑ and ↓ keys to change the displayed value to agree with the voltage measured by the voltmeter. This voltage should be larger than 1.200 and smaller than 2.200. **If the voltage is outside of these limits, the unit must be repaired.**

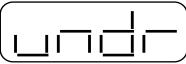
8. When the display matches the voltmeter reading, press ← key to accept the reading and to display the prompt for low calibration (V2). (The level of the tone will drop).

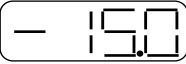
9. As with V1, the 0.350 represents an expected value. Use the ↑ and ↓ keys to change the displayed value to agree with the voltage measured by the voltmeter. This voltage should be larger than 0.250 and smaller than 0.450. **If the voltage is outside of these limits, the unit must be repaired.** However, if the display is greater than 0.350, turn the power OFF and restart the calibration.

10. Press  key again to accept the reading and display the self calibration prompt.  
11. Disconnect the voltmeter, then press the  key to start the self-calibration process.
- MEASURE will automatically go to L/F 15 kHz (L/F UNWTD on AM5e Classic ) and the appropriate LED will be lighted.
  - There will be a SEND display for the first calibration tone (typically):  
  - The self-calibration process takes about four (4) minutes. During this time various tone levels will be displayed in the left window, many of them preceded by a minus sign. (see step 12 for possible error).
  - The conclusion of the calibration will occur when the L/F UNWTD LED will go off, MEASURE will return to LEVEL FREQ lighted, and the DISPLAY selection will automatically go to MEAS lighted.
  - The DISPLAY selection will automatically go to MEAS and (since nothing is connected to the RX jack) will give an under-value reading.  
12. ERROR CONDITION: If the unit detects and error during the calibration process, an error reading may occur in the right display window (see example to the right). If this happens turn the unit off then back on so that the calibration can be performed again. An error may signify a defective unit, so Ameritec Customer Service should also be notified for further instructions.  

5. LINE FUNCTIONS

This section describes the Line Functions which set up the 2-Wire and 4-Wire interfaces to the AM5(e) Classic. It includes a functional block diagrams to illustrate LINE termination and signal routing within the unit, drawings of the test connector cables, and a description of each LINE selection. All line connections are made to the front panel jacks) or to corresponding terminals on the rear panel (shown to the right). Typical test configurations are also described in this section.

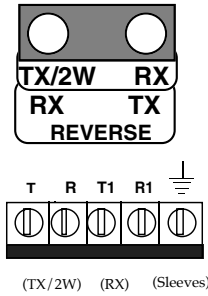

The AM5(e) Classic line connections are not polarity sensitive. Both the TX/2W T and R connections and the RX T1 and R1 connections can be reversed without affecting any measured values.

5.1 LINE CABLES

Figure 5-1 shows the line cables which may be ordered as accessories for the AM5(e) Classic. The bantam plug on any of the cables plugs into either the TX/2W or RX jack.

The bantam or the PL310 plug on the other end of the 48-0047 or 48-0048 cables can be plugged into jacks at the Central Office or other connectorized equipment.

The 48-0062 Line Cable has clip leads used to connect to instruments, terminal blocks, or other non-connectorized circuit points.

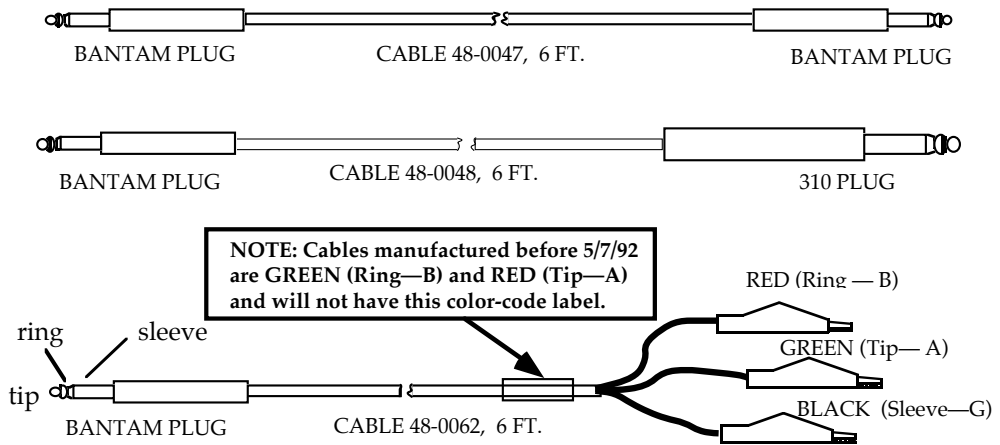

Figure 5-1 — Line Cable Accessories for AM5(e) Classic

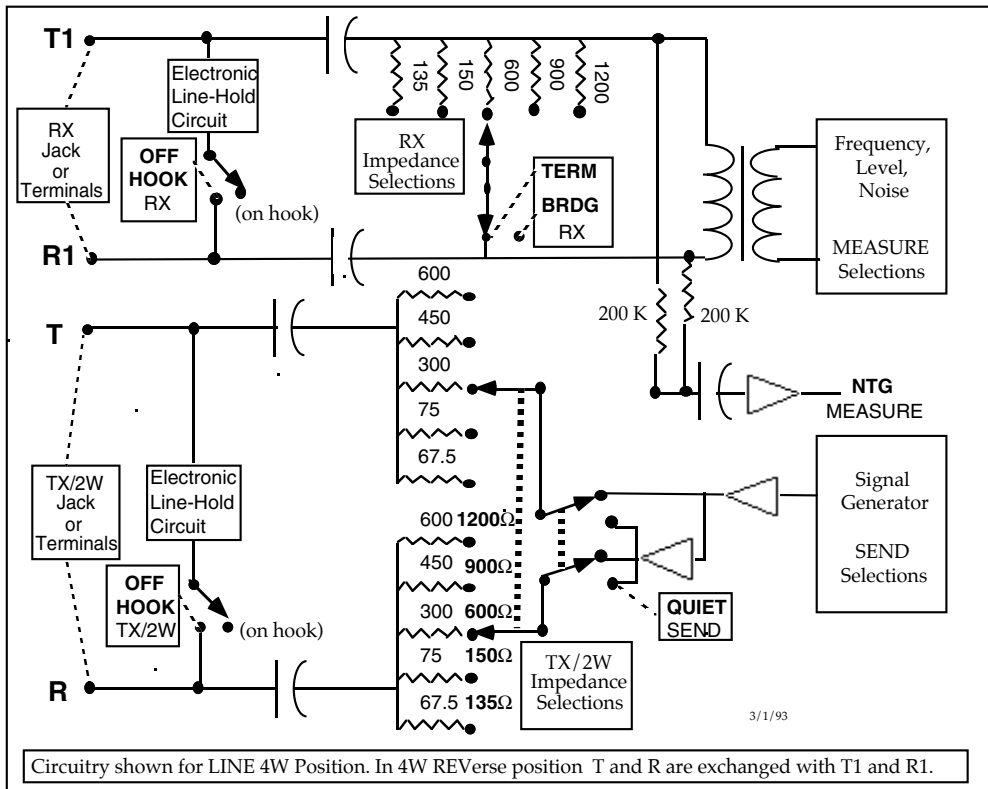
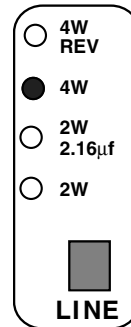

Figure 5-2 — 4-Wire Line Circuit Block Diagram

## 5.2 FUNCTIONAL DIAGRAMS OF AM5(e) CLASSIC

Figures 5-2 and 5-3 are Block Diagrams of the 4-Wire and 2-Wire line terminating circuitry. The following sub-sections describe the LINE circuit functions in terms of front-panel keys and the LEDs that show their selection.

- 5.2.1 LINE 4W selection:** In the 4-Wire configuration (Figure 5-2), signal flow is from the SEND functions out of the unit via the TX/2W jack (or rear-panel T and R terminals). Signal flow from the tested circuit is into the RX jack (or rear-pane T1 and R1 terminals) and into the MEASURE functions.
- 5.2.2 LINE 4W REVerse selection:** When in the 4-Wire REVerse configuration, the MEASURE and SEND functions are switched to the TX/2W and RX jacks, respectively (as indicated in note on Figure 5-2). The 4W REVerse setting is also useful for making receive-only measurements on a TX/2W line. Refer to NOTE at 5.2.11.



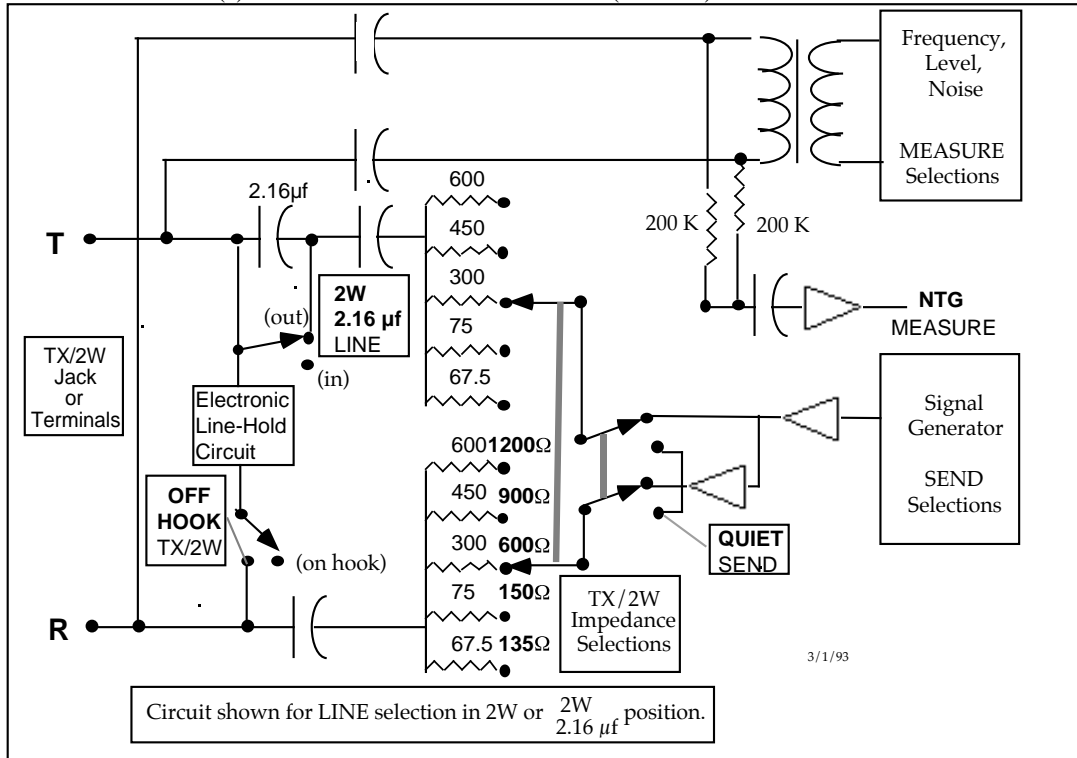

Figure 5-3 — 2-Wire Line Circuit Block Diagram

- 5.2.3 LINE 2W selection:** When in the 2-Wire configuration (Figure 5-3), the MEASURE and SEND functions are both connected to the TX/2W jacks. However, the RX OFF HOOK, and TERMinating selections are inoperative for the MEASURE functions. The impedance and loading coil selections are still reflected at the RX jacks.

*NOTE: dbm and dBrn calculation continue to be made based on the RX impedance selection (see 5.2.7 and 5.2.10).*

- 5.2.4 LINE 2W 2.16 $\mu$ f selection:** This is the same as described above, except for the insertion of a series capacitance of 2.16 $\mu$ f between the TX/2W jacks and the terminating TX/2W impedances. This selection is typically used with SEND QUIET mode for return loss measurements from the distant end of the circuit

- 5.2.5 DIAL terminal DIAL selection:** completely disconnects the TX/2W jack from the internal circuitry of the unit, and routes the tip and ring leads directly to the front-panel DIAL terminals. (If 4W REVERSE is selected, the RX jack is routed to the DIAL terminals). A circuit connected to the jack is only terminated by an instrument connected to the DIAL terminals. Terminals are labelled "TIP" and "RING" for an AM5 Classic (shown at right) and "A" and "B" for an AM5e Classic.

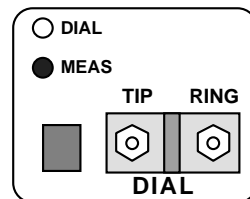

**5.2.6 TX/2W 135Ω , 150Ω, 600Ω, 900Ω, 1200Ω selections:** The SEND impedances are selected by the left TX/2W front-panel switch, and the corresponding LEDs are lighted for each impedance selection.

**5.2.7 TX/2W OFF HOOK selection:** The electronic equivalent of a loading coil (OFF HOOK) is selected by the right TX/2W switch.

**5.2.8 RX 135Ω , 150Ω, 600Ω, 900Ω, 1200Ω selections:** The MEASURE impedances are selected by the left RX front-panel switch, if **TERM** has been selected by the right RX switch. If **BRDG** has been selected, the impedance selector is disconnected and the impedance is 50 K or greater. Calculation of dBm and dBrn is based on the impedance selected (see 5.2.10).

**5.2.9 RX OFF HOOK selection:** The electronic equivalent of a loading coil (OFF HOOK) is selected by the middle RX switch. The holding coil presents a DC resistance of 200 or less while maintaining a high-impedance to AC.

**5.2.10 RX TERM or BRDG selection:** The MEASURE impedances are selected by the left RX front-panel switch, only if **TER**Minate has been selected by the right RX switch. If **BRDG** (Bridging) has been selected, the impedance selector is disconnected and the impedance at the RX jack is 50 K or greater.

*NOTE: dBm and dBrn readings displayed are calculated on the setting of the RX impedance switch, even though the network has been disconnected by the BRDG selection or because one of the LINE 2W selections has been made. The formula used is:*

$$dBm = \frac{10 \log (E^2 \times 1000)}{R}$$

Where: E = Voltage across the circuit  
R = Termination selection for the circuit

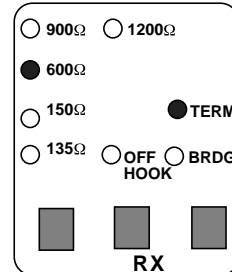
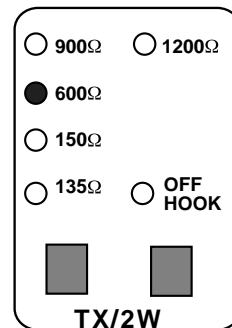

**5.2.11 SEND QUIET selection:** The signal generator is disconnected from the line when QUIET has been selected by the left SEND switch; however the TX/2W line remains terminated by the selected TX/2W impedance.

*NOTE: For an "open circuit" configuration refer to the description in sub-section 9.7.*

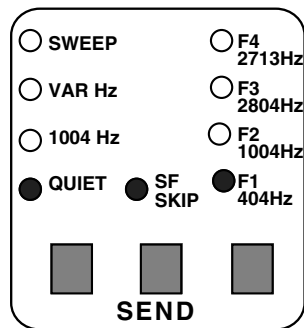

(AM5 Classic)

**5.2.12 SEND SF SKIP selection:** This is a lock-out which prevents the SEND circuits from sending any frequencies in the SF signaling band. It has no effect on the impedance presented to the TX/2W line.

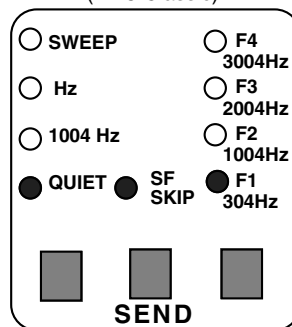

(AM5e Classic)

**5.2.13 FILTER selections:** Noise-Weighting Filters are selected by the left FILTER key, and are provided to limit certain parts of the signal spectrum being applied at the RX jack (or TX/2W in either 2W mode) from reaching the measure circuits. The filters have no effect on the impedance presented to the line, but they will affect the levels measured in accordance with the filter characteristics. Refer to Section 7 for filters supplied with the AM5 Classic and Section 8 for filters supplied with the AM5e Classic.

*NOTE: These filters are only switched into the circuitry when noise measurements are being made. Refer to Section 6.*

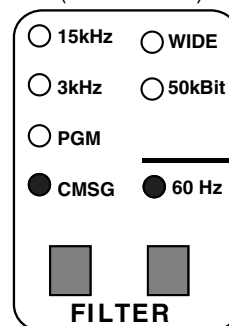

(AM5 Classic)

**5.2.14 FILTER 60 Hz selection:** The 60 Hz filter, selected by the right FILTER key produces a sharp roll-off in low frequency response below 60 Hz. It takes effect independently of other FILTER selections. Its primary purpose is to limit power-line interference from affecting readings. This filter has no effect on the impedance presented to the RX line.

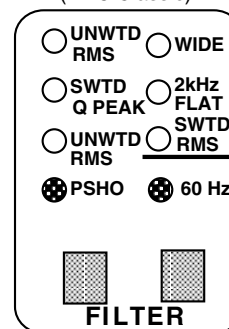

(AM5e Classic)

**5.2.15 MEASURE NTG selection:** When the NTG (Noise to Ground) function has been selected by the MEASURE switch, a balanced connection from both sides of the RX line (or TX/2W line if in a 2-Wire configuration) is made through 200 KΩ resistors to a high-gain amplifier which then is connected to the level measurement circuitry.

The frequency measurement circuitry is disconnected, and only noise in dBrn (for AM5 Classic) or dBm (for AM5e Classic) is displayed. (The right display reads "NTG-"). The ground connection must be made to the equipment ground for NTG measurements.

*NOTE: The sleeve or the rear-panel ground terminal must be connected to the ground of the equipment being measured. There is no continuity between the AM5(e) Classic ground and the chassis or the AC grounding lead.*

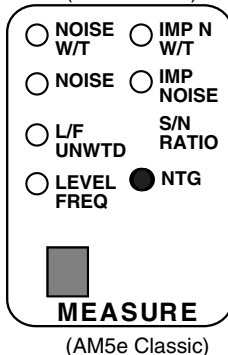
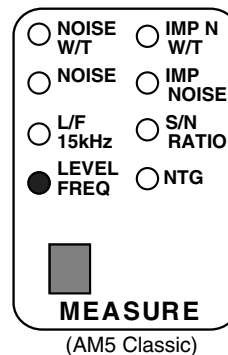

**5.2.16 MONITOR (TX, MEAS, RX) Selections:** The monitor switch (shown with its associated volume control) has no effect on the line connections. It allows the user to connect the built-in speaker to the TX/2W circuit, the RX circuits, or the internal automatic-gain-control amplifier which is used for RX measurements. The MEAS selection permits the user to hear low-level noise on the RX circuit which would be inaudible in the RX position.

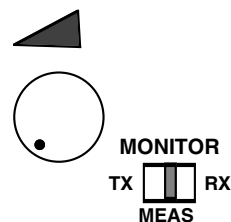

**5.2.17 DISPLAY (SEND, MEAS) Selections:** Like the MONITOR switch, the DISPLAY selections have no effect on line connections. The selections of the DISPLAY key connect the internal level and frequency measurement circuits to either the TX/2W circuits or the RX circuits.

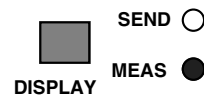

*NOTE: The MEASURE parameters for IMPulse NOISE (with or without tone) must be set in the MEAS position (Refer to sub-section 6.7.2). All other parameters are set in the SEND position (Refer to Section 9).*



### 5.3 LINE TERMINATION IMPEDANCES

For correct level measurements and to ensure that the tested equipment operates properly, the correct terminating impedance must be selected. The AM5(e) Classic can terminate TX/2W lines with 135, 150, 600, 900, or 1200  $\Omega$  impedance (see 5.2.6).

RX lines may be similarly terminated. In addition for a 4-Wire line, the Bridging position provides a high-impedance (greater than 50,000  $\Omega$ ). Bridging is useful where measurements are made on a circuit between two interconnected pieces of equipment which are already properly terminated to one another (see 5.2.8).

The terminations provided by the AM5(e) Classic are resistive for AC and open-circuit for DC. However, for some types of 2-Wire lines, a series capacitance may be inserted into the circuit through the LINE 2W 2 $\mu$ f selection.

For TX/2W or RX circuits which require a DC path between tip and ring (A and B), the OFF HOOK selection provides the electronic equivalent of a loading coil. OFF HOOK provides a DC path of 200 $\Omega$  or less for DC, while maintaining the AC impedance that has been selected.

The general guidelines for terminating lines correctly are:

1. For 4-Wire circuits
  - Select proper impedance for incoming (RX) line unless the line is already terminated and the AM5(e) Classic is being used to monitor the line. If monitoring, set BRDGing and then set the impedance to correspond to the impedance of the circuit being monitored.

*NOTE: Impedance must be set to obtain proper level measurements. This is necessary because RX level calculation is based on the RX impedance setting. For more information refer to 5.2.10*

- Select proper impedance for outgoing (TX) line.
- If a DC path is required, select OFF HOOK.

2. For 2-Wire circuits

- Select proper impedance for the TX/2W line. To obtain proper level measurement calculations, set the RX impedance to match since level measurements are based on the RX impedance settings (see NOTE above).
- If a low-value series capacitance is required, select LINE 2W 2.16 $\mu$ f.
- If a DC path is required, select OFF HOOK.

*NOTE: An external instrument connected to the DIAL terminals should also be set to match the impedance of the TX/2W line that is connected to the TX/2W jack. No internal AM5(e) Classic circuitry is connected when the DIAL is selected.*

### 5.4 TEST CONFIGURATIONS

There are three basic AM5(e) Classic configurations for testing 2-Wire and 4-Wire circuits.

- End-to-end which requires two AM5(e) Classic units
- Loopback
- Tests with remotely-located responders

The remainder of this sub-section describes these configurations, and their advantages and disadvantages.

*NOTE: End-to-End and responder testing may be performed on either 2-wire or 4-wire lines. Loopback testing requires a 4-wire line.*

**5.4.1 End-to-End Testing:** Measurements on telephone transmission lines are usually made by applying an appropriate signal (single tone or a sweep of tones) at one end of the transmission line and measuring the level at the other end of the circuit.

End-to-end testing is the most reliable method for testing near-to-far impairments and any differences between near-to-far and far-to-near transmission paths. The major disadvantage is that it requires a test set and an operator at each end.

Figure 5-4 shows an example end-to-end test situation. Somewhere in a telephone network, a four-wire circuit carries full-duplex communications between a computer (CPU) and a terminal device (DTE). MODEMS are used at each end to convert the DC voltage levels that are required by the CPU and the DTE to tones which are transmitted over the circuits.

If the circuit does not meet the transmission requirement of the MODEMS due to inadequate frequency response, signal loss, or excessive noise, there will be errors in the transmission of data. When this occurs, the MODEMS are disconnected and an AM5(e) Classic is substituted.

Measurements can then be made in either direction by having the AM5(e) Classic at the CPU-end SEND while having the AM5(e) Classic at the DTE-end MEASURE. After checking level, frequency response, and noise, the process is then reversed with the AM5(e) Classic at the DTE-end SENDING.

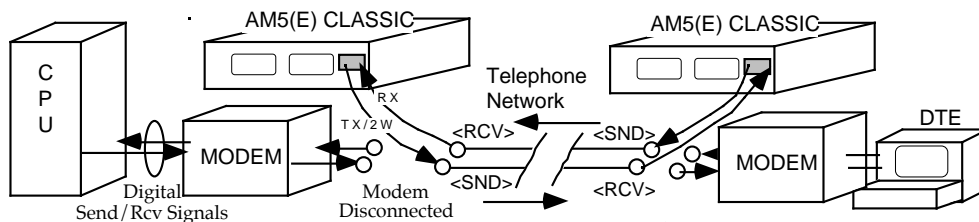

Figure 5-4 — 4-Wire End-to-End Testing Configuration

**5.4.2 Loopback Testing:** The distant end of a 4-Wire transmission circuit can be looped back manually by changing cross-connects or by patch cords at a Central Office or through the use of a remotely-controlled loop-back device such as a Western Electric Model 829 or an Ameritec AM3-4A Responder. (Responders can do additional tests as described in 5.4.3).

The AM5(e) Classic at the near end sends (from the TX/2W jack) a signal into the

SND pair which travels to the RCV pair at the far end. At the far end the loopback connection joins the incoming RCV pair to the outgoing SND pair and the signal is returned to the near end.

The AM5(e) Classic receives the signal (into the RX jack) from the near-end RCV pair and measurements are made on the incoming signal. By comparing SEND levels with MEASURED levels, line degradation can be measured.

*NOTE: A loopback test cannot be done on 2-Wire circuits because signals can not be sent and measured simultaneously on the same pair.*

The advantage of loopback testing is that only one AM5(e) Classic and one operator is needed at the test site.

Though loopback testing is more convenient and less costly than end-to-end testing, it is also less reliable. The disadvantage is that it does not identify transmission impairments in each direction. In fact, a satisfactory loopback measurement could actually hide impairments in each direction which cancel each other out.

To perform a loopback test with a Western Electric Model 829 at the far end and an AM5 Classic at the near end test site:

1. Connect the TX/2W jack to the SND pair of a 4-Wire circuit, and connect the RX jack to the RCV pair. Ground the sleeves (or ground terminal) to the CO ground if Noise-to-Ground tests are required.
2. Turn off SF SKIP, if lighted, then send a brief 2713 Hz tone from the AM5 Classic. (If a different loopback frequency is required, set the QUIET mode parameter for F4 to that frequency before sending the tone.) This will activate loopback in the distant Model 829.

(To send the tone, repeatedly press the right SEND key until F4 is flashing. Then press and hold the right SEND key for over three seconds until F4 is lighted steady. After about five seconds, press the key again briefly to stop the tone.)

3. As required, SEND the required test signals and make the desired measurements on the looped back test signal. (If frequency sweeps are made, be sure SF SKIP is ON to avoid false commands to the Model 829.)
4. To end the test, repeat step 2 to deactivate loopback in the distant Model 829.

**5.4.3 4-Wire Testing with Responder:** Most of the advantages of both end-to-end and loopback testing can be achieved if multifunction responders, such as Ameritech's AM3-4A (4-Wire DTMF Commandable V.F Responder) or AM3-2 (2-Wire DTMF Commandable V.F. Responder), are located at the far end of circuits which may require testing.

Like 4-Wire loopback testing, the use of a responder eliminates the need for another AM5(e) Classic and operator at the far end. In addition to loopback tests, the responder can generate tones which can be measured by the AM5(e) Classic; therefore, one-way impairments from far-to-near and near-to-far end can also be measured. Figure 5-5 shows a typical 4-wire test configuration using an AM3-4A

Responder. An example test procedure follows:

1. Connect the TX/2W jack to the SND pair of a 4-Wire circuit, and connect the RX jack to the RCV pair. Ground the sleeves (or ground terminal) to the CO ground if Noise-to-Ground tests are required.
2. Connect a handset (capable of generating DTMF signals) to the DIAL terminals on the front panel and press the key beside the terminals until DIAL is lighted. (this disconnects all internal AM5(e) Classic circuitry).
3. Send the required DTMF digits to command the responder into the "milliwatt mode"; it will send 1004 Hz at 0 dBm. (For this and other responder commands refer to the AM3-4A Responder Instruction Manual — 18-0025).
4. Press the key beside the DIAL terminals so that MEAS is lighted, then select MEASURE LEVEL FREQ)..
5. Select the MEASure Display and note the Level and Frequency displayed in the LED display windows.
6. Repeat steps 2 and 3 with the DTMF digits to command the responder into loopback mode.
7. Select SEND 1004 Hz (level should be 00.0 dBm) then perform step 5 again to determine the loopback received Level and Frequency. Compare with the one-way test to determine impairment in the near-to-far end direction.
8. When finished with the test, repeat steps 2 and 3 with the DTMF digits to command the responder to "reset" (go into "THRU" data mode).

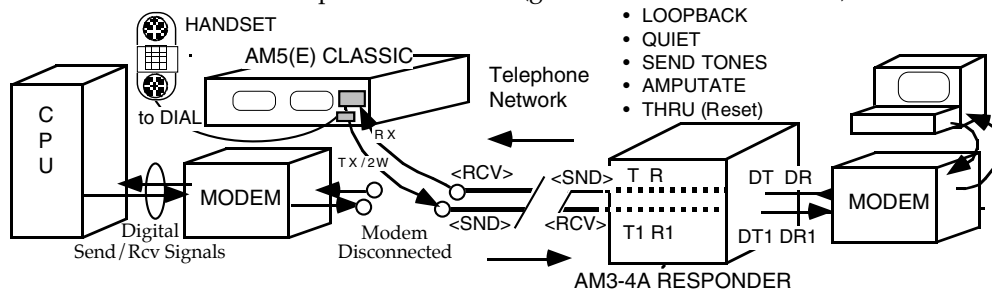

Figure 5-5 – 4-Wire Testing with Responder

**5.4.4 2-Wire Testing with Responder:** On a 2-Wire network, dial access responders are very useful in measuring far-to-near impairments. An Ameritec AM3-2C (Automatic Milliwatt Test Line) or AM3-2A (DTMF Commandable 2-Wire Responder) can be dialed up over the network by connecting an external handset to the DIAL terminals of the AM5(e) Classic and selecting the DIAL connection.

Figure 5-6 (shows a 2-Wire network with responders and AM5(e) Classic units at strategic locations. This configuration allows end-to-end testing (one direction at a time) between the two AM5(e) Classic units, and allows testing with any responder in the network from either of the AM5(e) Classic units.

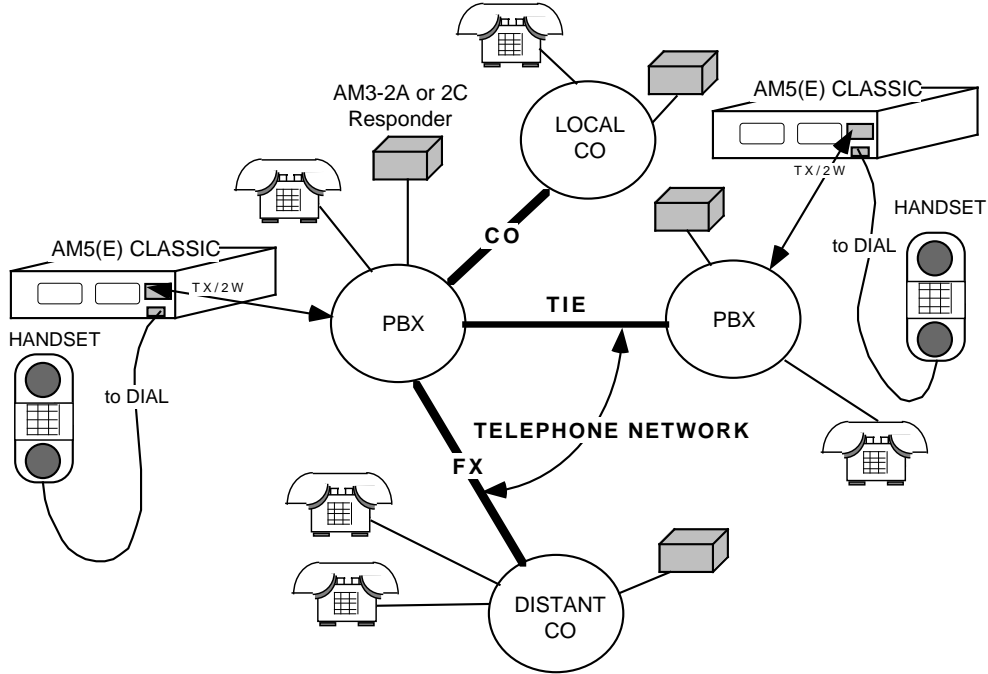

Figure 5-6 — 2-Wire Testing with Responders

A 2-Wire network is typical of a business or residential environment where a user dials up a distant location (switched access line) through a PBX and/or a Central Office.

The responders are connected to distant telephone numbers just like any other end-instrument. Like any end-instrument, a responder remains on-hook until a ringing signal is sent to it. It then goes off-hook automatically, (within 2.5 seconds) and applies a tone (usually 1.004 kHz at -10.0 dBm) to the line. The responder then goes quiet and waits for DTMF digits which will command it into its various modes of operation or cause it to go on-hook.

Different DTMF digits can be sent to the responder to command it into its test modes. The AM3-2C can be used to perform far-to-near tests to determine far-to-near level and frequency, idle channel noise, and noise with tone.

In addition to the AM3-2C functions, the AM3-2A can also be used to perform far-to-near gain slope and near-to-far level tests. In near-to-far tests the responder receives a tone from the AM5(e) Classic. Results are then transmitted as a frequency deviation of a returned signal. This can be observed at the AM5(e) Classic.

Both responders are described in one Instruction Manual, "Model AM3-2A DTMF Commandable 2 Wire Responder and Model AM3-2C Automatic Milliwatt Test Line Instruction Manual" (18-0006).

(END OF SECTION 5)

## 6. MEASURE FUNCTIONS AND PARAMETERS

The AM5(e) Classic contains highly versatile detectors and filters which are connected to the receive line under test. The term MEASURE refers to the detection mode that has been selected by the MEASURE key to detect and display the characteristics of the received signal. The labels for the LEDs above the MEASURE key are different for the AM5 Classic and the AM5e Classic to accommodate the characteristics of IEEE Standard or CCITT Recommendations. The front panel areas for MEASURE functions are shown below:



This section describes all the MEASURE functions in the order they are selected by each press of the MEASURE key (bottom to top, left to right). Unless otherwise specified, the descriptions apply to both the AM5 Classic and the AM5e Classic. Views of the LED indicators and displays showing typical readings are provided. A lighted LED is shown by shading, as shown by above defaults.

If the LINE selection is 4W , the signal being measured must be connected to the RX jack (or T1 and R1 terminals).

If the LINE selection is 4W REVERSE, 2W, or 2W+2.16 $\mu$ f, the signal being measured must be connected to the TX/2W jack (or T and R terminals).

For NTG (Noise-to-Ground) measurements, a reference ground must be connected to the ground terminal on the rear panel or to the sleeve terminal of the RX (or TX/2W) bantam jack.

Impulse Noise (IMP NOISE) and Impulse Noise with Tone (IMP N W/T) are the only MEASURE functions that have parameters.

### 6.1 MEASURE LEVEL AND FREQUENCY (LEVEL FREQ)



To measure level and frequency, an auto-ranging amplifier, average detector, and frequency counter are connected to the signal. A 120 kHz low-pass filter is used for full bandwidth operation. (In the -200 kHz models a 200 kHz filter is used). The detected average voltage is converted to dBm, based on the impedance selected for the RX line.

To display the measured level and frequency, select MEAS with the DISPLAY key. If the incoming level is 1004 Hz at a level of -10 dBm, the display will appear as shown below.

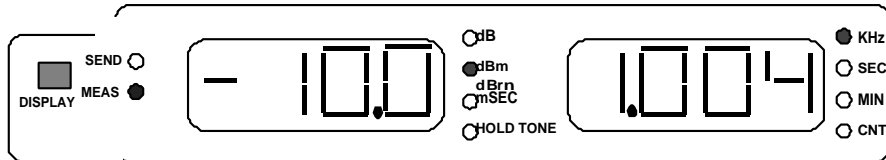

If there is power line interference present on the circuit that could interfere with the measurement, select the 60 Hz filter by pressing the right FILTER key so the 60 Hz LED is lighted.

*NOTE: None of the filters, selectable by the left FILTER key, apply to the Level and Frequency measurements; their LEDs are not lighted.*

If high frequencies are of no interest, use the narrow band measurement function described in the next sub-section.

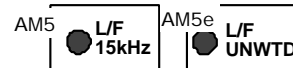

### 6.2 MEASURE LEVEL AND FREQUENCY, NARROW BAND (L/F 15 kHz or L/F UNWTD)

This is a level and frequency measurement which includes a low-pass filter in the measurement circuits. It is useful for making measurements on voice-band circuits where high-frequency components are of no interest or could interfere with measurements. The filter has the following characteristics:

- AM5 Classic 15 kHz low-pass
- AM5e Classic Low Frequency (Sound) Unweighted 30 Hz to 20 kHz

### 6.3 MEASURE IDLE LINE NOISE (NOISE)



The Noise selection is a high-gain measurement of level only. It is designed to make "Idle Line" measurements. Level is displayed in the left display window, and the right window is unlighted. Noise measurement range and accuracy are as follows:

- AM5 Classic 10 to 20 dBm at  $\pm 2$  dBm; 20 to 100 dBm at  $\pm 1$  dBm with CMSSG filter selected.
- AM5e Classic 80 to -70 dBm at  $\pm 2$  dBm; -70 to +10 dBm at  $\pm 1$  dBm with PSHO Filter selected.

**6.3.1 Units of Noise Measurement:** For noise measurements, the voltage of the received signal is measured with an RMS detector on an AM5 Classic. For an AM5e Classic both RMS detection and Quasi-Peak (Q PEAK) detection is available. Q PEAK detection (and appropriate filtering) is selected with the FILTER key.

The voltage is first converted to dBm. The RX impedance selected determines the voltage to dBm conversion.

In an AM5e Classic the dBm measurements are displayed in the left display. For example, if the noise level were -40 dBm, the display would appear as follows:

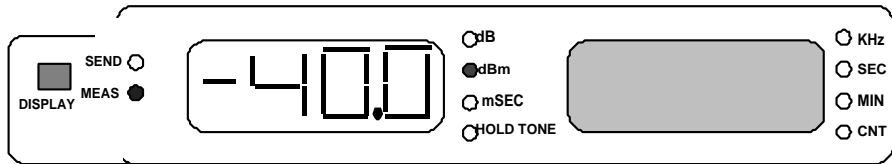

In an AM5 Classic, the reading is further converted to dB<sub>rn</sub> (decibels relative noise). The dB<sub>rn</sub> measurement is designed to present a 0 reading for an optimally quiet line (-90 dBm) and is determined by the formula  $dB_{rn} = dBm + 90$ . A -40 dBm noise level would read 50 dB<sub>rn</sub> on an AM5 Classic as below:

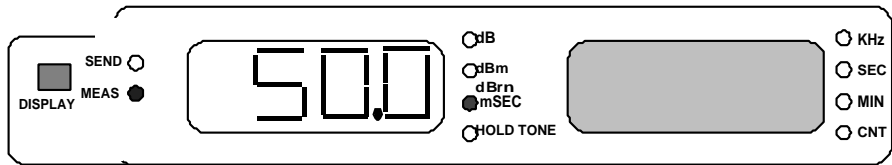

A comparison of dBm and dB<sub>rn</sub> units of measurement is shown in Figure 3-3 and below:

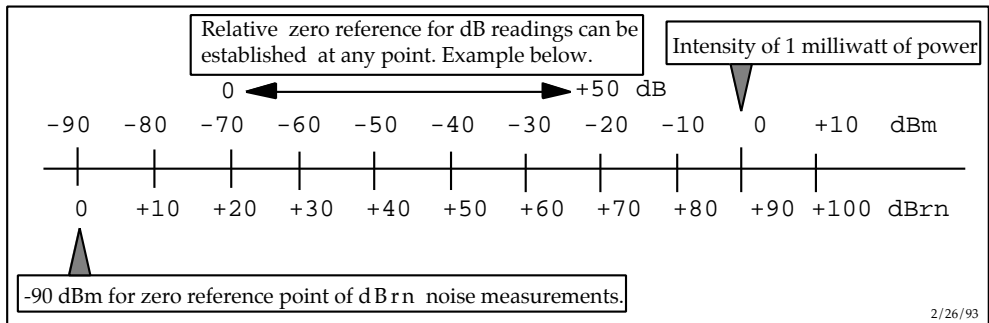



**6.3.2 Test Setup for Idle Line Noise:** For a typical noise measurement, there must be no signal on the received line. For end-to-end tests using AM5(e) Classic units, the far-end unit SEND function should be set to QUIET while the near-end unit MEASURE function is set to NOISE. (Refer to Figures 5-3, 5-4, and 5-5 for typical locations of equipment).

Where a responder is installed at the far-end, an external handset should be connected to the DIAL terminals, the DIAL function selected, and the responder's number called. When the responder answers, send the appropriate code to put it into the QUIET mode.

For loopback tests, one AM5(e) Classic is used. The SEND selection is QUIET and the MEASURE selection is NOISE.

**6.3.3 Noise Weighting Filters:** The default filter selection is usually used for idle-line noise measurements (CMSSG for the AM5 Classic; PSHO for the AM5e Classic). Other filters may be selected by the left FILTER key to "weight" the measurement over the band of frequencies that is important for the circuit. Noise Weighting Filters for the AM5 Classic and AM5e Classic are described in detail in Sections 7 and 8, respectively. A summary of filters will also be found in sub-section 3.3.17.

**6.4 MEASURE NOTCH NOISE (NOISE W/T)**



The Noise with Tone test (also referred to as Notch Noise test) measures noise on a circuit which has a 1004 Hz tone applied to it. (On many types of circuits a signal is required to hold the circuit active.) The tone is removed in the measuring circuit of the AM5(e) Classic through a 1010 Hz notch filter, then the residual noise is measured. Both level and frequency displays operate when this function is selected. (See 6.3 for units of noise measurement).

**6.4.1 Validity of Notch Noise:** In order for a Notch Noise measurement to be valid, the AM5(e) Classic must be receiving a tone as indicated by HOLD TONE being lighted (green). When HOLD TONE is lighted it indicates that the received signal is at a frequency of 995 Hz to 1025 Hz at a level greater than -40 dBm. (individual units may vary slightly in this range). If there is measurable noise, the noise will be displayed in the left display and the frequency of the hold tone will show in the right display.

The UNDR (under-range) indication will be displayed, if the noise is below the measurement range, and the frequency will not be shown:

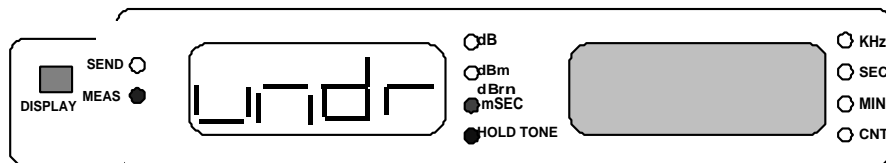

**6.4.2 Test Setup for Notch Noise:** For a typical notch noise measurement, there must be a hold-tone signal on the measured circuit. For end-to-end tests using AM5(e) Classic units, the far-end unit SEND function should be set to 1004 Hz at a level sufficient to ensure a received level of greater than -40 dBm, while the near-end MEASURE function is set to NOISE W/T. (Refer to Figures 5-3, 5-4, and 5-5 for typical locations of equipment).

Where a responder is installed at the far-end, an external handset should be connected to the DIAL terminals, the DIAL function selected, and the responder's number called. When the responder answers, send the appropriate code to put it into the "send 1004 Hz" mode.

For loopback tests, one AM5(e) Classic is used. The SEND selection is 1004 Hz and the MEASURE selection is NOISE W/T.

**6.4.3 Noise Weighting Filters:** The default filter selection is usually used for Notch-Noise measurements (CMSSG for the AM5; PSHO for the AM5e Classic). Other filters may be selected by the left FILTER key to "weight" the measurement over the band of frequencies that is important for the circuit. Filters are described in detail in Sections 7 and 8. A summary of filter types will also be found in sub-section 3.3.17.

## 6.5 MEASURE NOISE TO GROUND (NTG)



Noise-to-Ground is measured by internally summing the signals on the Tip and Ring wires on the measured circuit within the AM5(e) Classic, then measuring the noise through a selected filter, with reference to ground.

The ground reference must be connected through the ground screw terminal on the rear panel (Figure 3-4) or through the sleeve contact of the RX (or TX/2W if in a 2-Wire LINE selection) bantam jack.

**6.5.1 Noise to Ground Measurement Range:** The range of the noise to ground measurements differs from those shown in sub-section 6.3 in that the range is shifted toward the high-level end as follows:

- AM5 Classic            40 to 129 dBm at  $\pm 1.5$  dBm
- AM5e Classic        -50 to +39 dBm at  $\pm 1.5$  dBm

The NTG level is displayed in the left display window, while the right display window is not used. If the NTG level is below those shown above, "undr" is displayed. (Refer to example under 6.4.1). The following shows a 100 dBm measurement (on an AM5 Classic). The AM5e Classic would read 10 dBm (not shown) for the same noise level.

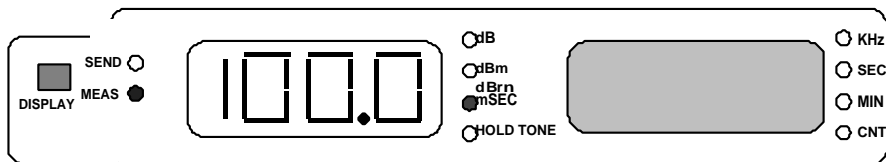

- 6.5.2 Test Setup for NTG:** A noise-to-ground test does not require any external equipment, but the correct impedance for the line being measured should be set by the RX key. Though signals may be applied between the Tip and Ring leads of the RX line, these will not affect the test results unless the line is unbalanced.
- 6.5.3 Noise Weighting Filters:** The default filter selection is usually used for NTG measurements (CMSSG for the AM5; PSHO for the AM5e Classic). Other filters may be selected by the left FILTER key to "weight" the measurement over the band of frequencies that is important for the circuit. Filters are described in detail in Sections 7 and 8. A summary of filter types will also be found in subsection 3.3.17.
- 6.5.4 NTG and SEND functions:** Selection of NTG affects the functions controlled by the SEND key. For NTG readings, QUIET must be selected, and both SEND displays will show dashes. QUIET parameters may be changed while in the NTG position.

If any other left SEND key functions are selected, "nTG-" is displayed in the right window, and 1004 Hz, VAR Hz, and SWEEP functions are disabled (regardless of their LED indicator status), and their parameters cannot be changed.

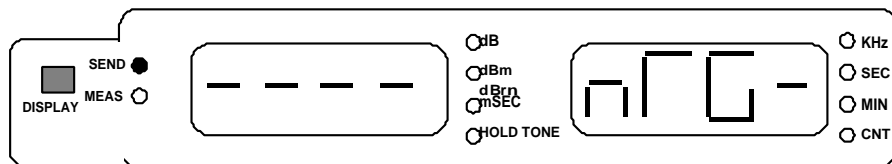

The single-tones selected by the right SEND key can still be used to send signals out of the TX/2W jack. When a single tone is sent, Level and Frequency are displayed.

## 6.6 SIGNAL-TO-NOISE RATIO (S/N RATIO)



The Signal-to-Noise Ratio measurement is similar to the Noise with Tone measurement. A 1004 Hz test tone is expected on the measured circuit. The valid signal range is -40 to +10 dBm.

The receive circuit contains an average detector, a notch filter (previously described under 6.4), a noise weighting filter, and an RMS detector. The AM5e Classic provides Quasi-Peak (Q-PEAK) or RMS Detectors which may be switched (along with associated filters) by the FILTER key.

**6.6.1 Signal-to-Noise Ratio Measurements:** The range of the S/N Ratio measurements is 10 to 50 dB with accuracy as follows:

- 10 to 40 dB at  $\pm 1$  dB
- 40 to 45 dB at  $\pm 2$  dB
- 45 to 50 dB at  $\pm 3$  dB

The measurement technique for S/N Ratio incorporates the following steps which are automatically repeated while the measurement is being made:

1. The average detector measures the amplitude of a received holding tone (1004 Hz) and keeps this value in memory. This is the "signal" reading. The incoming signal range is -40 to +10 dB.
2. The 1004 Hz signal is notched out, and the RMS (or Q-PEAK) detector measures the signal again. This is the "noise" reading.

*NOTE: The "noise" reading, could be 0 to 40 dBrn (-90 to -50 dBm) for a -40 dBm holding tone, up to 40 to 80 dBrn (-50 to 0 dBm) for a +10 dBm holding tone. If the "noise" reading is less than 20 dBrn (-70 dBm), the accuracy of the computed S/N ratio is reduced to  $\pm 2$  dBm unless CMMSG or PSHO filter is used.*

3. A computation occurs which determines the difference, in dB between the "signal" (step 1) and the "noise" (step 2). The result is the signal-to-noise ratio.
4. This value is displayed in the left display window as a range of 10 to 50 dB. The holding tone frequency is displayed in the right display window. For example, a measured S/N ratio of 30 dB and 1004 Hz hold tone would be displayed as follows:

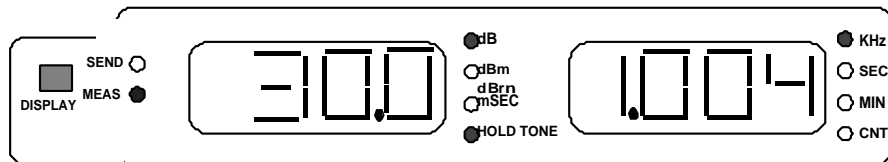

For a line that is so quiet that the S/N ratio exceeds 50 dB, the left window will show "oVer" as illustrated below:

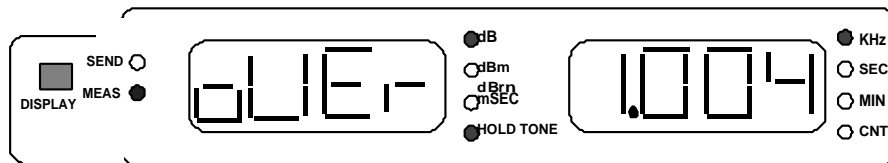

A very noisy line (worse than 10 dB), would show "undr" and the right window would be blank. The HOLD TONE indicator will be lighted but kHz is not. Tones outside the notch band are treated as noise and may be filtered.

- 6.6.2 Test Setup for S/N Ratio:** For S/N Ratio measurement there must be a hold-tone signal on the measured circuit. For end-to-end tests using AM5(e) Classic units, the far-end unit SEND function should be set to 1004 Hz at a level of greater than -40 dBm, while the near-end unit MEASURE function is set to S/N RATIO (Refer to Figures 5-3, 5-4, and 5-5 for typical locations of equipment).

Where a responder is installed at the far-end, an external handset should be connected to the DIAL terminals, the DIAL function selected, and the responder's number called. When the responder answers, send the appropriate code to put it into the "send 1004 Hz" mode.

For loopback tests, one AM5(e) Classic is used. The SEND selection is 1004 Hz and the MEASURE selection is NOISE W/T.

- 6.6.3 Noise Weighting Filters:** The default filter selection for S/N Ratio measurements (CM5G for the AM5 Classic and PSHO for the AM5e Classic) are normally used. Other filters may be selected by the left FILTER key to "weight" the measurement over the band of frequencies that is important for the circuit.

On an AM5e Classic, two of the filter selections also select the Q-Peak detector. The remaining filters provide RMS detection. Filters are described in detail in Sections 7 and 8. A summary of filter types will also be found in sub-section 3.3.17.

- 6.7 IMPULSE NOISE WITHOUT TONE (IMP NOISE) or  
IMPULSE NOISE WITH TONE (IMP N W/T)**



- 6.7.1 General Description of Impulse Noise Measurement:** Impulse noise testing is a timed study which counts and stores the number of noise pulses that exceed each of three levels (thresholds). The use of a holding tone is optional for impulse noise tests, and this description applies to either selection.

*NOTE: Information on setup for noise tests and filters is provided in sub-sections 6.7.4 through 6.7.6.*

The time over which the test will be run is set by a duration parameter ("dur"). The lowest level noise threshold is set by the impulse threshold ("iTHd") parameter.

The two higher-level thresholds are set by the delta threshold ("idLT") parameter. The delta determines the level interval between the thresholds and can be set at 2, 4, or 6 dB. To control the way that the pulses are counted, a blanking interval parameter ("bLnC") is also provided. This parameter is used by the blanking interval counter.

When a pulse first exceeds a threshold, it is counted. Then the blanking interval counter starts. While the blanking interval is in effect, no further pulses will be counted. The purpose of the blanking interval is to minimize the effect of ringing on the count by providing a time for the ringing to die down.

Without a blanking interval, several counts could be made immediately after the first pulse, due to secondary pulses caused by ringing. (For more explanation and a graphic representation, refer to 6.7.3).

After the parameters are set, the measurement display must be selected. Then the impulse noise test is started by pressing the START/STOP key. When the key is pressed, the IMPULSE NOISE RUNNING indicator flashes and a running count is kept of the number of pulses that exceed each threshold.

*NOTE: While the Impulse Noise test is running, the MEASURE key is inoperative.*

While the test is running, the elapsed time ("TiME"), can be displayed and will count up by .1 minute (6 second) steps. The three impulse noise counters ("iLo", "iMid", and "iHi") and noise on the circuit ("noiS") may be displayed while the test is in progress. Counter and time measurements are saved after the test is stopped.

The test stops automatically when the time set by the duration parameter is reached. The test also may be stopped while the test is running by pressing the START/STOP key.

**6.7.2 Impulse Noise Measurements, Parameters, and Procedure:** The following procedure displays the impulse noise measurements (Figure 6-1) and displays/or sets the impulse noise parameters (Figure 6-2). Finally, it runs the test:

1. Press the MEASURE key until the IMP NOISE or IMP N W/T indicator is lighted.
2. Be sure that the DISPLAY key is in the MEASure position.
3. The left display should identify one of the measurements; the appropriate indicator will also be lighted.

Display	Measurement	Range	LED
TiME	Minutes	0.1 — 999.9	MIN
iHi	High threshold impulse count	0 — 9999	CNT
iMid	Mid threshold impulse count	0 — 9999	CNT
iLo	Low threshold impulse count	0 — 9999	CNT
noiS	Noise on line (AM5) (AM5e)	30.0 — 110.0 -60.0 — 10.0	dBrn dBm

*NOTE: Time of 0.0 and counts of 0 will be displayed if the test has never been run before. If tests have been run before, the measurements from the last test will be shown until reset by starting another impulse noise test. Noise is always displayed as received (even when test is not running).*

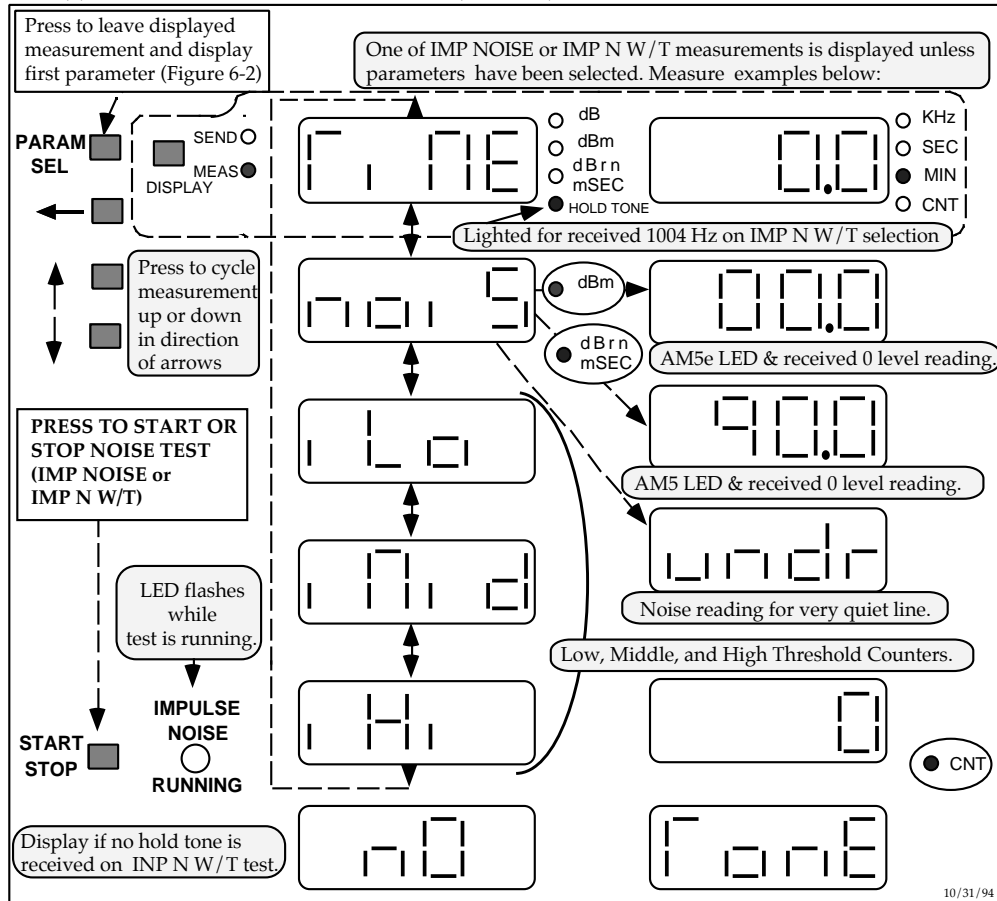

Figure 6-1 — Impulse Noise Measurement Selection/Display

4. The right display will display a time, impulse counter, or a noise measurement. In Figure 6-1, the example 90 dBrn reading (0 dBm on an AM5e Classic) would occur if a 1004 Hz “noise” signal at 0 dBm were being received for a MEASURE selection of IMP NOISE.

That same signal with a MEASURE selection of IMP N W/T would probably display “undr” if the line was very quiet.

5. To display additional measurements press the up- or down-arrow key. The identification and the current value will be displayed (refer to step 3 and Figure 6-1).
6. To display the first parameter (duration), press the PARAMETER SELECT key once. (Refer to Figure 6-2).

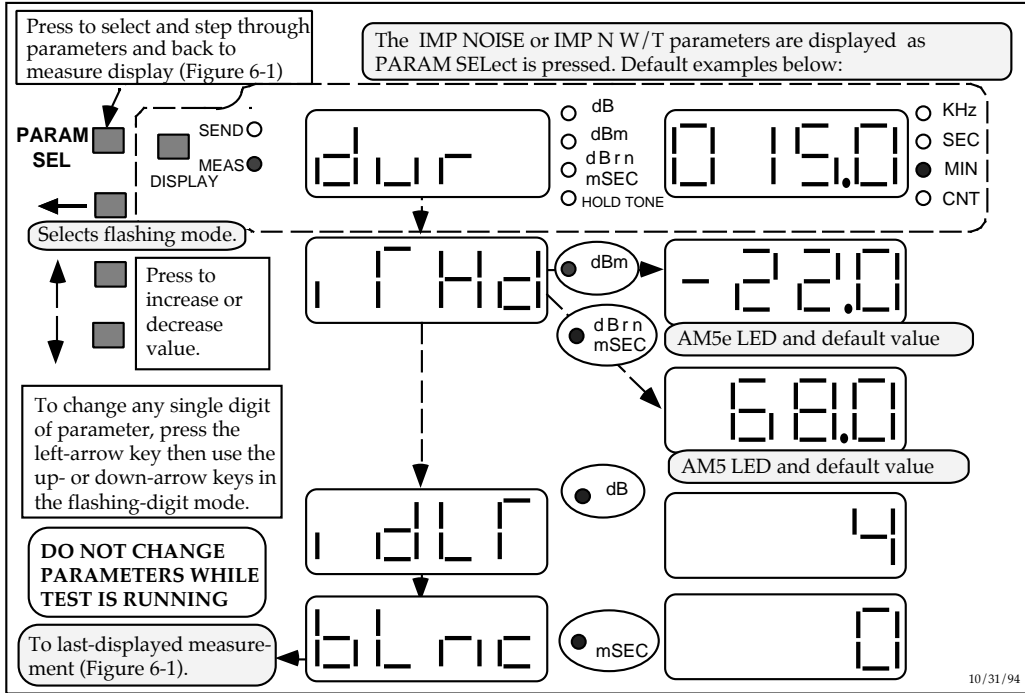

Figure 6-2 — Impulse Noise Parameters Selection/Display

- The left display will identify the parameter and the right display will show the value. Each time the PARAMeter SElect key is pressed, additional parameters are displayed as shown below:

Display	Parameter	Range <default>	LED
dur	duration	0.1 <15.0> 999.9	MIN
iTHd	impulse (low-level) (AM5) threshold (AM5e )	20 <68.0> 110 -70 <-22> 20	dBrn dBm
idLT	impulse delta (interval between low, medium and high thresholds)	2, <4>, 6	dB
bLnC	blanking interval	0.0 <125> 255	mSEC

- After all parameters have been displayed, the last selected measurement will be displayed (Figure 6-1). (See steps 3 and 4).
- To set a different parameter press the PARAMeter SElect key until the parameter is identified in the left window.



10. To set a displayed parameter value, use the arrow keys, as needed.
11. Repeat steps 8 through 10 until all values desired have been set. Then select measurements (step 8).
12. To run the impulse noise test, press the START/STOP key. The IMPULSE NOISE RUNNING indicator will flash while the test is being run.

*NOTE: For Impulse Noise with Tone test, "no TonE" will be displayed and test will not start if hold tone is not being received by the AM5(e) Classic*

13. To observe the measurements while the test is running, press up- or down-arrow key until the desired measurement is displayed.
14. The test will stop when the duration has been reached, or the test may be stopped manually by pressing the START/STOP key so the IMPULSE NOISE RUNNING indicator is not lighted.
15. After the test is stopped, the final measurements should be reviewed by performing steps 2 – 5.

**6.7.3 Evaluation of Measurement Data:** Although the noise, and counters can be observed while the test is in progress, the final evaluation should be made after the test has stopped.

Figure 6-3 graphically shows an impulse noise test. Default parameters are shown in bold boxes and type, while example final measurements are shown in light boxes and type.

1. While the test is running, impulse spikes that exceed one of the three thresholds set the counters as shown by sequence number following each spike.
2. The blanking interval, shown by cross-hatch, prevents any counts from being registered for a short period of time after a pulse is received. This is illustrated in Figure 6-3 by the uncounted spikes within the cross-hatched areas.
3. Noise is constantly measured. For an AM5 Classic the measurement will reflect the average RMS measurement in dBm.

For an AM5e Classic, the noise measurement will reflect the average RMS noise unless either UNWTD Q PEAK or SWTD Q PEAK filter was selected for Q PEAK detection. The Q PEAK measurement will be for peak noise. All AM5e Classic measurements are in dBm.

4. The test may be stopped manually, or it will stop automatically when the duration is reached.
5. After the test is stopped, the final impulse counter measurements may be examined.
6. Calculation will be required to determine the absolute number of lower-level impulses, since the lower counters are set by higher-level impulses.

(e.g:  $iLo - iMid = iLo_{abs}$ ;  $iMid - iHi = iMid_{abs}$ )

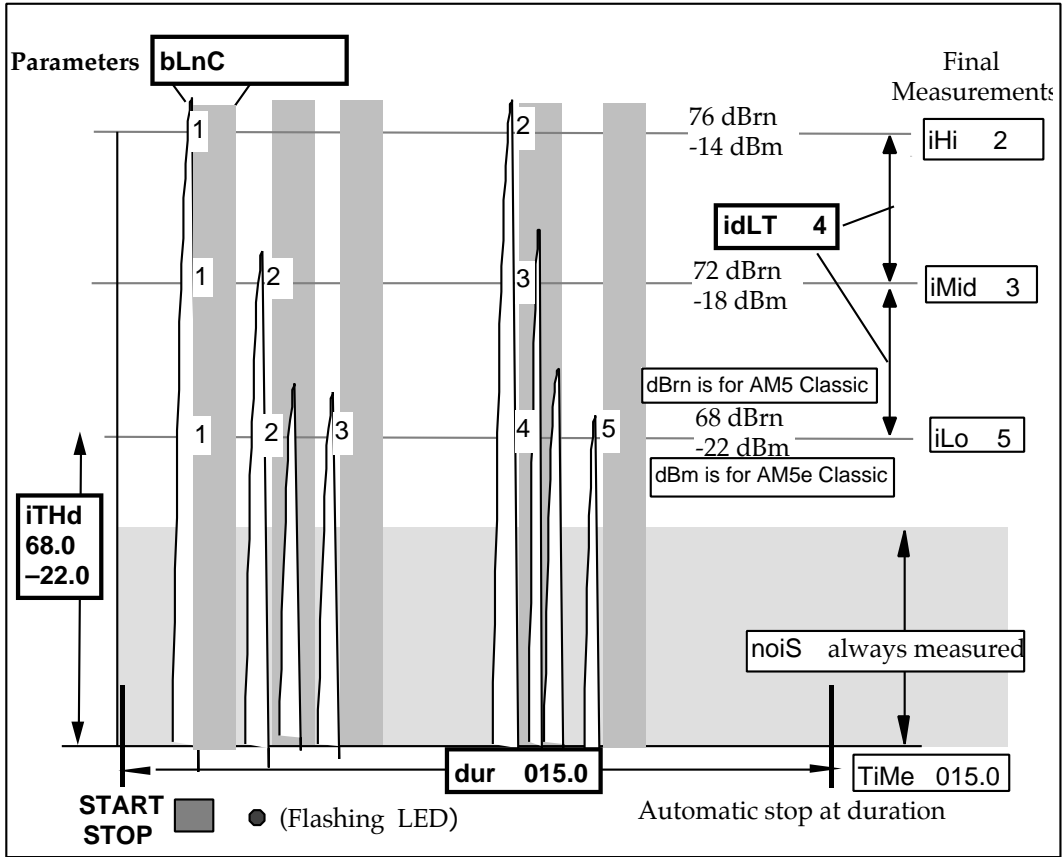

Figure 6-3 — Illustration of Impulse Noise Measurement

- 6.7.4 Test Setup for Impulse Noise without Tone:** For a typical impulse noise without tone measurement, there should be no signal on the measured circuit.

For end-to-end tests using AM5(e) Classic units, the far-end unit SEND function should be set to QUIET while the near-end unit MEASURE function is set to IMP NOISE. (Refer to Figures 5-3, 5-4, and 5-5 for typical locations of equipment).

Where a responder is installed at the far-end, an external handset should be connected to the DIAL terminals, the DIAL function selected, and the responder's number called (refer to sub-section 3.3.29). When the responder answers, send the appropriate code to put it into the QUIET mode.

For loopback tests, one AM5(e) Classic is used. The SEND selection is QUIET and the MEASURE selection is IMP NOISE.

- 6.7.5 Test Setup for Impulse Noise with Tone:** For Impulse Noise with Tone measurement there must be a hold-tone signal on the measured circuit.

For end-to-end tests using AM5(e) Classic units, the far-end unit SEND function should be set to 1004 Hz (at a level sufficient to ensure a received level of greater than -40 dBm so that the HOLD indicator is lighted).

The near-end unit MEASURE function is set to IMP N W/T (Refer to Figures 5-3, 5-4, and 5-5 for typical locations of equipment).

Where a responder is installed at the far-end, an external handset should be connected to the DIAL terminals, the DIAL function selected, and the responder's number called (refer to sub-section 3.3.29). When the responder answers, send the appropriate code to put it into the "send 1004 Hz" mode.

For loopback tests, one AM5(e) Classic is used. The SEND selection is 1004 Hz and the MEASURE selection is IMP NOISE W/T.

- 6.7.6 Noise Weighting Filters:** The default filter selection for impulse noise measurements (CM5G for the AM5 Classic and PSHO for the AM5e Classic) are normally used. Other filters may be selected by the left FILTER key to "weight" the measurement over the band of frequencies that is important for the circuit.

On an AM5e Classic, two of the filter selections also select the Q-Peak detector. The remaining filters provide RMS detection.

Filters are described in detail in Sections 7 and 8. A summary of filter types will also be found in sub-section 3.3.17.

(END OF SECTION 6)

## 7. IEEE NOISE WEIGHTING FILTERS FOR AM5 CLASSIC

This Section describes the filters that are supplied with the AM5 Classic. Except for the 60 Hz filter, which is common to the AM5 and the AM5e Classic, the filters described comply with the IEEE 743-1984 Standards and are used for noise measurements described in Section 6 (sub-sections 6.3 through 6.7). The front panel area for FILTER is shown to the right. Default selections are shown by shading.

*NOTE: The default indication for CMSG does not apply to the default MEASURE LEVEL FREQ selection. The CMSG default will come on when any MEASURE noise function is selected, then go out when MEASURE LEVEL FREQ or L/F 15 kHz are selected. No noise weighting filter can be selected while LEVEL FREQ or L/F 15 kHz are selected.*

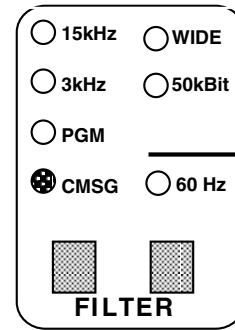

A low-pass filter (L/F 15 kHz) can be selected by the MEASURE key for level/frequency measurements only. The response of this filter rolls off frequencies above 15 kHz (refer to 7.3).

A 995 Hz to 1025 Hz notch filter is automatically switched in when measuring noise with (1004 Hz) tone, impulse noise with tone, or signal-to-noise ratio (NOISE W/T, IMP NOISE W/T, S/N RATIO). This filter is not illustrated.

### 7.1 NOISE WEIGHTING FILTERS

Noise weighting filters are selected by each press of the left FILTER key (bottom to top, left to right). Other than the lighted LED, there are no displays or parameters associated with the FILTER selections.

Only one noise weighting filter can be selected at a time, but the 60 Hz filter (refer to 7.2) may be selected in addition to the noise weighting filter to eliminate AC power interference. The noise weighting selections are summarized below, and the curves for the filters are shown in the referenced figures.

FILTER	DESCRIPTION	IEEE/Bell STANDARD	CURVE
CMSG	C-Message bandpass	743-1984/41009	Figure 7-1
PGM	Program bandpass	"	Figure 7-2
3 kHz	3 kHz low pass (3 dB down @ 3 kHz, 12 dB/octave rolloff.	"	Figure 7-3
15 kHz	15 kHz low pass (3 dB down @ 15 kHz, 12 db/octave rolloff.	"	Figure 7-4
50 kBit	Combination low pass and high pass.	"	Figure 7-5
WIDE	20 Hz to 120 kHz (-120) 20 Hz to 160 kHz (-200)	"	Figure 7-6 Figure 7-7

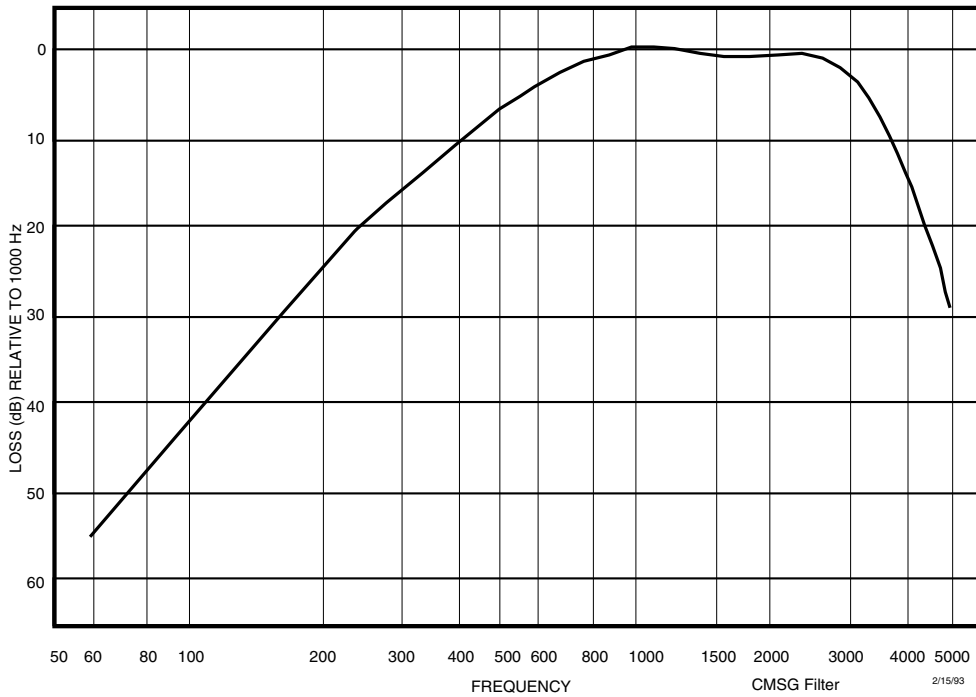

CMSG WEIGHTING CHARACTERISTIC

Frequency (Hz)	Design Loss (dB) & Tolerance	Frequency (Hz)	Design Loss (dB) & Tolerance
60	55.7 ± 2 dB	1300	0.7 ± 1 dB
100	42.5	1500	1.2
200	25.1	1800	1.3
300	16.3	2000	1.1
400	11.2 ± 1 dB	2500	1.1
500	7.7	2800	2.0
600	5.0	3000	3.0 ± 2 dB
600	2.8	3300	5.1
800	1.3	3500	7.1 ± 3 dB
900	0.3	5000	14.6
1000	0.0 0 dB	4500	22.3
1200	0.4 ± 1 dB	5000	28.7
			See Note

NOTE: Attenuation continues to increase at a rate of not less than 12 dB per octave until it reaches a value of 60 dB.

Figure 7-1 — CMSG Bandwidth Filter (CMSG)

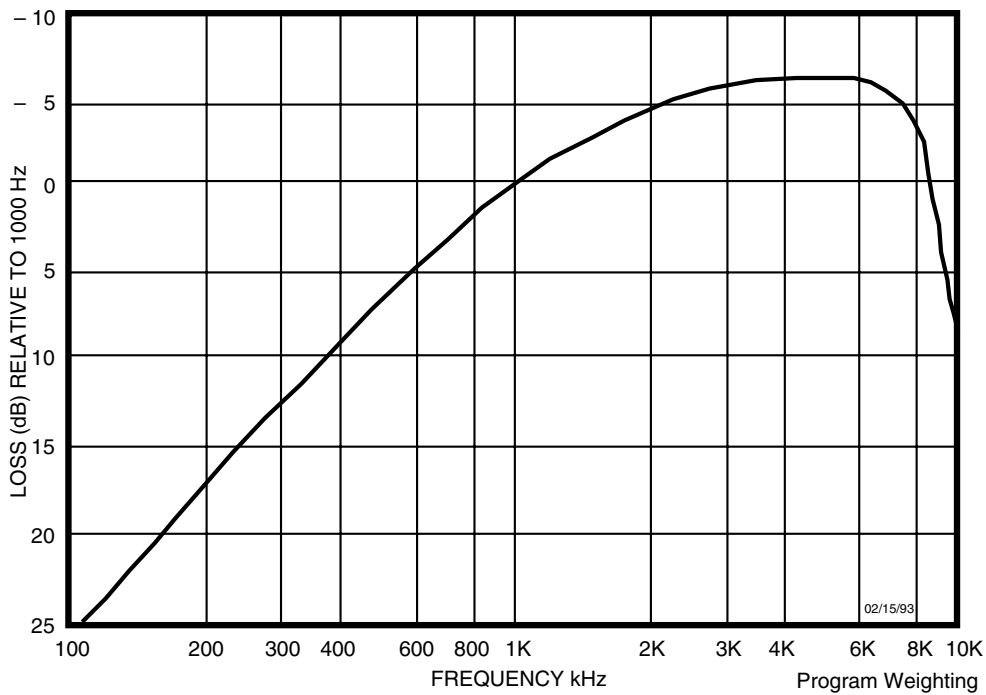

PROGRAM WEIGHTING CHARACTERISTIC

Frequency (Hz)	Design Loss (dB) & Tolerance	Frequency (Hz)	Design Loss (dB) & Tolerance
100	26.3 ± 2 dB	1500	-3.2 ± 1 dB
200	17.3	2000	-4.8 ± 2 dB
300	12.2	2500	-5.6
400	9.0	3000	-6.0
500	6.6 ± 1 dB	4000	-6.5
600	4.7	5000	-6.5 ± 3 dB
700	3.2	6000	-6.4
800	2.0	7000	-5.8
900	0.8	8000	-4.0 ± 4 dB
1000	0.0 Ref	9000	-1.5
		10000	8.5
			See Note

NOTE: Attenuation continues to increase at a rate not less than 12 dB per octave until the insertion loss is not less than 60 dB.

Figure 7-2 — Program Bandpass Filter (PGM)

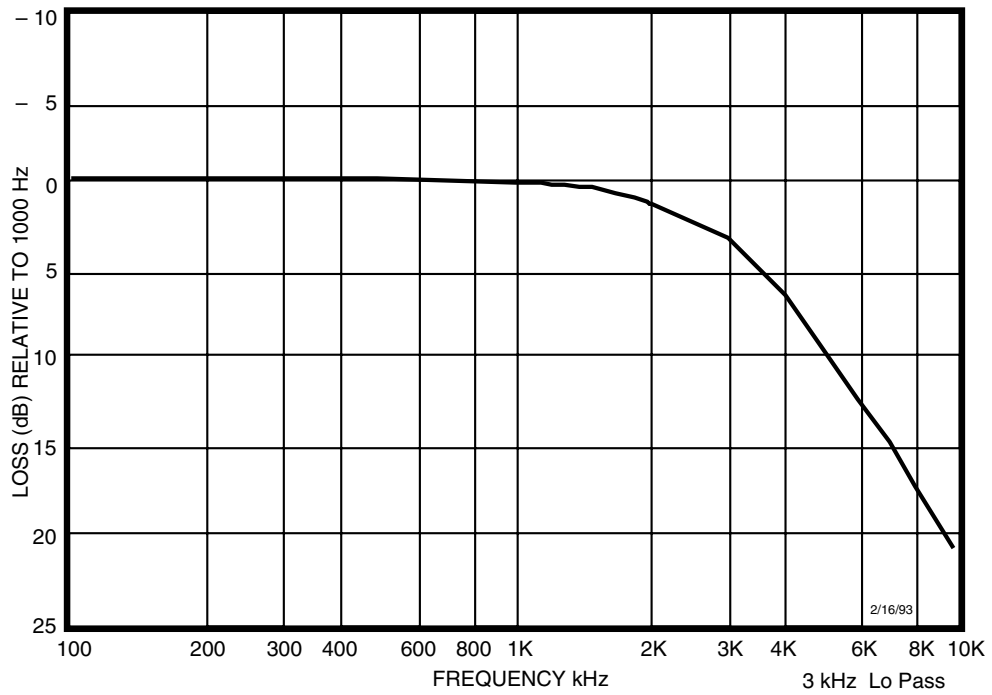

3 kHz WEIGHTING CHARACTERISTIC

Frequency (Hz)	Design Loss (dB)	Frequency (Hz)	Design Loss (dB)
500	0.0	6000	12.3
1000	0.1 (Ref)	7000	14.9
2000	0.8	8000	17.1
3000	3.0	9000	19.1
4000	6.2	10000	21.0
5000	9.4		See Note

NOTE: Attenuation continues to increase at a rate not less than 12 dB per octave until the insertion loss is not less than 60 dB.

Figure 7-3 — 3 kHz Low Pass Filter (3 kHz)

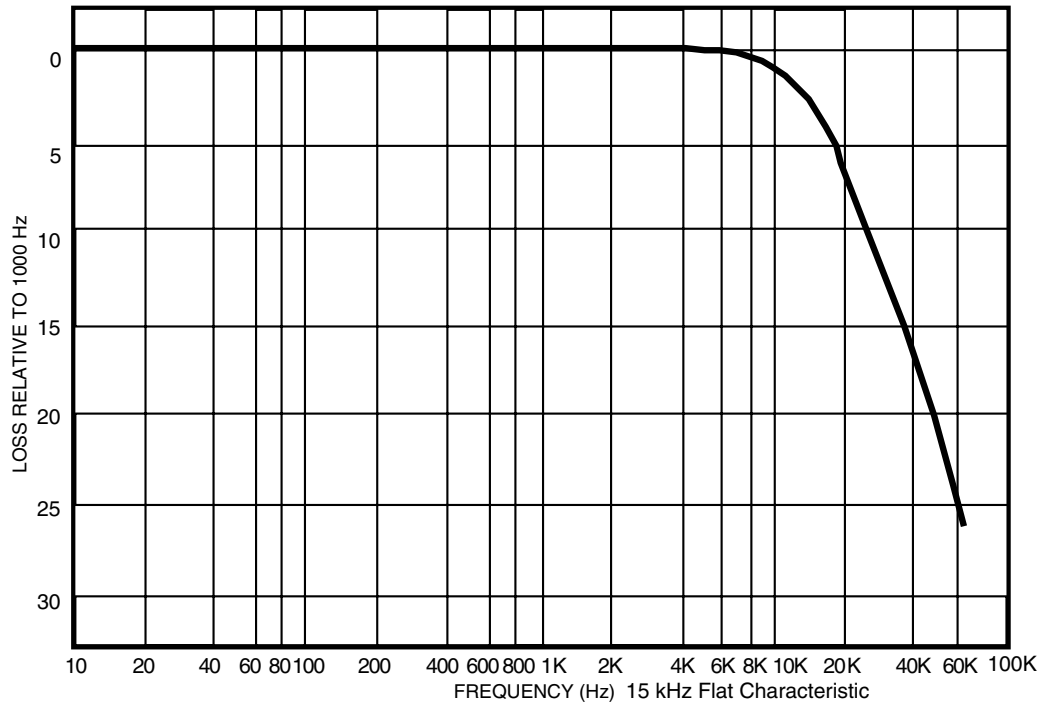

15 kHz FLAT CHARACTERISTIC

Frequency (Hz)	Design Loss (dB)	Frequency (Hz)	Design Loss (dB)
1000	0.0 (Ref)	30000	12.3
5000	0.1	35000	14.9
10000	0.8	40000	17.1
15000	3.0	45000	19.1
20000	6.2	50000	21.0
25000	9.4		See Note

NOTE: Attenuation continues to increase at a rate not less than 12 dB per octave until the insertion loss is not less than 60 dB.

Figure 7-4 — 15 kHz Low Pass Filter (15 kHz)



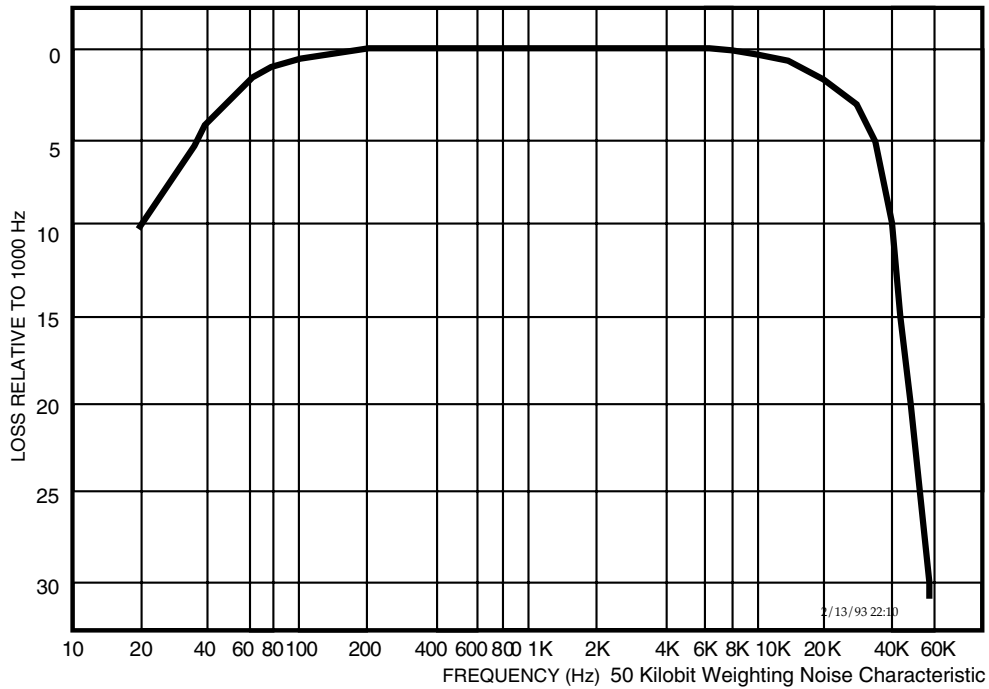

50 KILOBIT WEIGHTING CHARACTERISTIC

Frequency (Hz)	Design Loss (dB) & Tolerance	Frequency (Hz)	Design Loss (dB) & Tolerance
0	>30	30000	3.3 ± 1.5 dB
50	2.7 ± 1.5 dB	35000	5.0 ± 1.7
200	0.2 ± 0.5	40000	7.8 ± 2.0
1000	0.0 ± 0.2 (Ref)	45000	14.0 ± 3.0
5000	0.1 ± 0.5	50000	>22.0
10000	0.3 ± 0.3	>55000	>30.0
15000	0.7 ± 1.0		
20000	1.3 ± 1.0		
25000	2.1 ± 1.0		

Figure 7-5 — 50 Kilobit Filter (50 kBit)

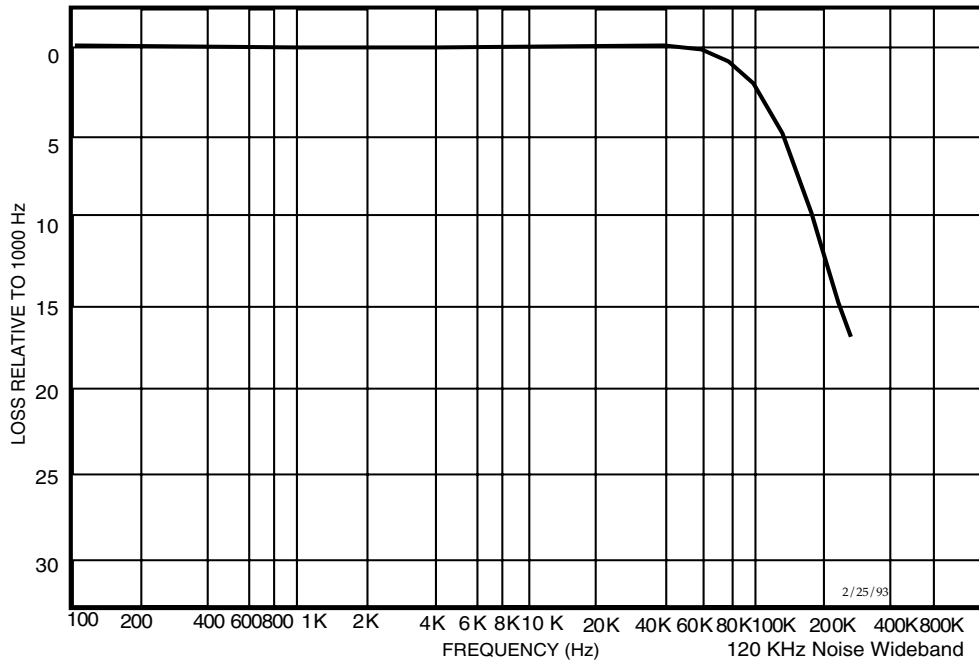

Figure 7-6 — Wideband 120 kHz Filter (WIDE — AM5-120 Model)

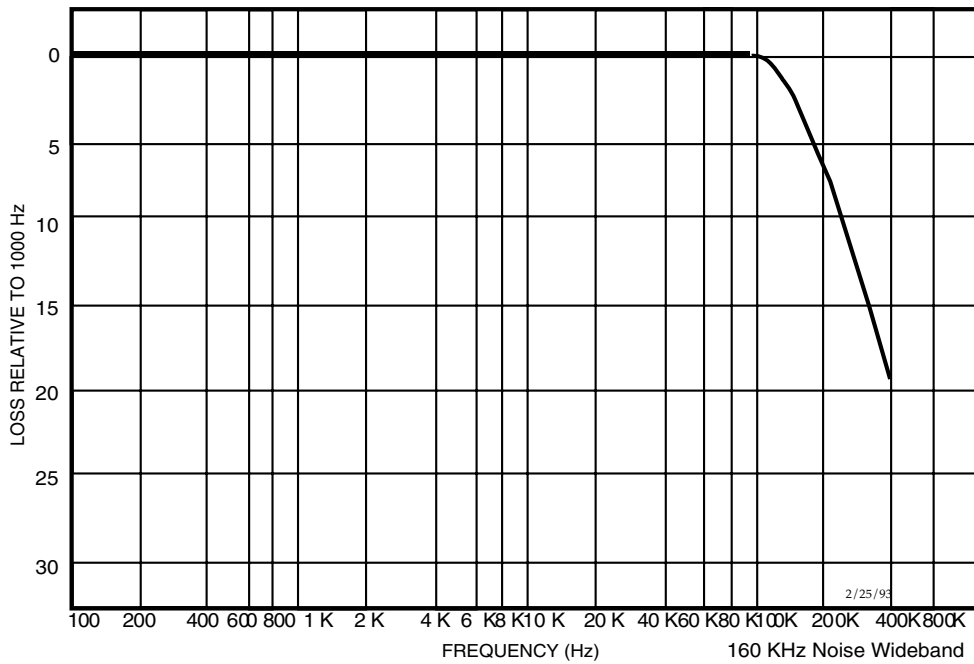

Figure 7-7 — Wideband 160 kHz Filter (WIDE — AM5-200 Model)

## 7.2 60 Hz FILTER

The 60 Hz high-pass filter is provided to eliminate frequencies of 60 Hz or lower. Power line interference due to 60 Hz, 50 Hz or lower components may cause erratic readings on the display. Connect this filter to eliminate interference as follows:

1. Press right filter key to connect the 60 Hz filter. 60 Hz LED is lighted.
2. Press right filter key again to disconnect the filter. 60 Hz LED is not lighted.

## 7.3 L/F 15 kHz MEASURE FILTER

When the MEASURE L/F 15kHz function is selected, a low-pass filter is connected to the front end of the measurement circuitry, effectively eliminating high-frequency components. The characteristics of this filter are the same as those shown in Figure 7-4. For more details on MEASURE selections refer to Section 6.

*NOTE: As is the case with the MEASURE LEVEL FREQ function, average detection is used with the MEASURE L/F 15 kHz function.*

None of the Noise Weighting Filters, previously described and illustrated in subsection 7.1, will be active (even if previously selected) when L/F 15 kHz or LEVEL FREQ functions are being used.

(END OF SECTION 7)

## 8. CCITT NOISE WEIGHTING FILTERS FOR AM5e CLASSIC

This Section describes the filters that are supplied with the AM5e Classic. Except for the 60 Hz filter, which is common to the AM5 and the AM5e Classic, the filters described comply with CCITT Recommendations and are used for noise measurements described in Section 6 (sub-sections 6.3 through 6.7). The front panel area for FILTER is shown to the right. Default selections are shown by shading.

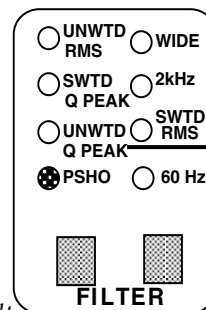

*NOTE: The default indication for PSHO does not apply to the default MEASURE LEVEL FREQ selection. The PSHO default will come on when any MEASURE noise function is selected, then go out when MEASURE LEVEL FREQ or L/F UNWTD are selected. No noise weighting filter can be selected while LEVEL FREQ or L/F UNWTD are selected.*

A low-pass filter (L/F UNWTD) can be selected by the MEASURE key for level/frequency measurements only. The response of this filter rolls off frequencies above 15 kHz (refer to 8.3).

A 995 Hz to 1025 Hz notch filter is automatically switched in when measuring noise with (1004 Hz) tone, impulse noise with tone, or signal-to-noise ratio (NOISE W/T, IMP NOISE W/T, S/N RATIO). This filter is not illustrated.

### 8.1 NOISE WEIGHTING FILTERS

Noise weighting filters are selected by each press of the left FILTER key (bottom to top, left to right). Other than the lighted LED, there are no displays or parameters associated with the FILTER selections.

Only one noise weighting filter can be selected at a time, but the 60 Hz filter (8.2) may be selected in addition to the noise weighting filter to eliminate power interference. The noise weighting selections are summarized below, and the curves for the filters are shown in the referenced figures. The UNWTD and SWTD filters permit selection of RMS or Quasi-Peak (Q-PEAK) detectors. The other filters use RMS detection.

FILTER SELECT	DESCRIPTION	RECOMMEN-DATION	CURVE
PSHO	Psophometric Bandpass	CCITT P.53	Figure 8-1
UNWTD Q-PEAK	Sound Un-Weighted low- pass, high-pass with Quasi-Peak detection.	CCITT J.16	Figure 8-2
SWTD Q-PEAK	Sound-Weighted low-pass, high-pass with Quasi-Peak detection.	CCITT J.16	Figure 8-3
UNWTD RMS	Same filter as UNWTD Q-PEAK but with RMS detection	CCITT J.16	Figure 8-2
SWTD RMS	Same filter as SWTD Q-PEAK but with RMS detection	CCITT J.15	Figure 8-3
2 kHz FLAT	Bandpass 750 – 2300 Hz	CCITT O.71	Figure 8-4
WIDE	20 Hz to 120 kHz (-120) 20 Hz to 160 kHz (-200)	— —	Figure 8-5 Figure 8-6

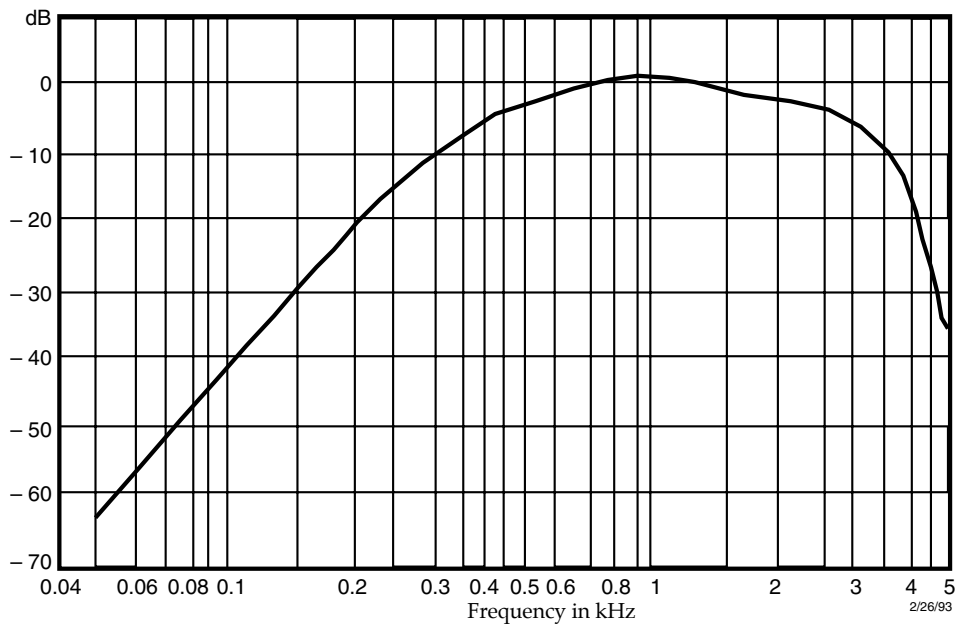

PSOPHOMETRIC WEIGHTING CHARACTERISTIC

Frequency (Hz)	Response (dB) & Tolerance	Frequency (Hz)	Response (dB) & Tolerance
50	- 63,0 ± 2 dB	1000	+ 0,9 ± 1 dB
100	- 41,0	1200	0,0
150	- 29,0	1500	- 1,3
200	- 21,0	2000	- 3,00
300	- 10,6 ± 1 dB	2500	- 4,20
400	- 6,3	3000	- 5,60 ± 2 dB
500	- 3,6	3500	- 8,5 ± 3 dB
600	- 2,0	4000	-15,0
800	- 0,0 ± 0 dB	5000	- 36,0

Note: Per CCITT documentation conventions, decimal points are represented by commas “,” in this section.

Figure 8-1 — Psophometric Filter (PSHO)

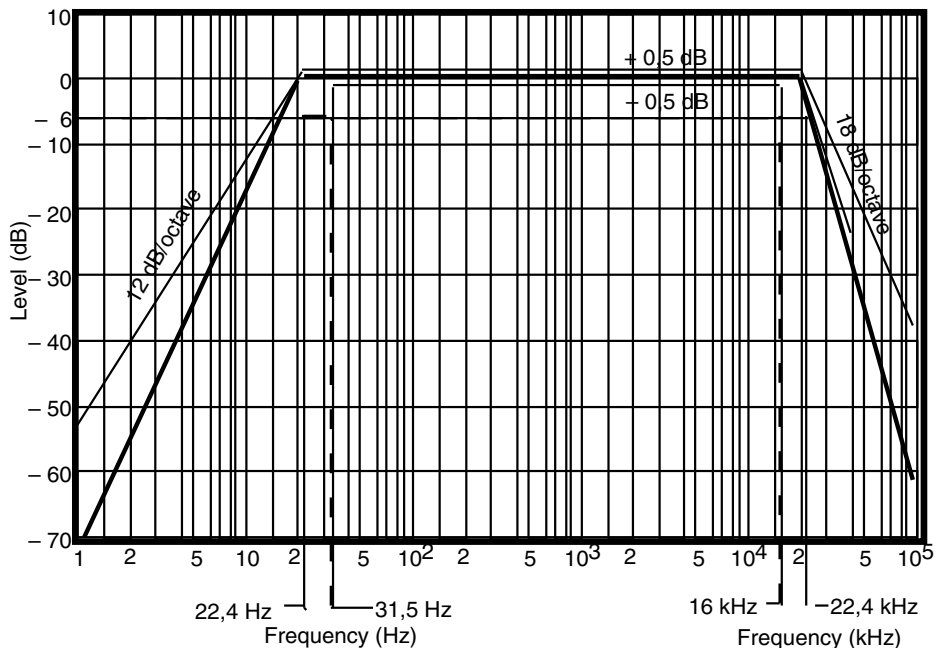

SOUND UNWEIGHTED FILTER CHARACTERISTICS

The Frequency Response for the Unweighted Filter is within the limits shown in the above figure. The AM5e Classic implements the low-frequency slope (shown by the heavy lines) at 18 dB/octave from 20 Hz. The upper-frequency slope is 24 dB/octave from 20 kHz. Response from 20 to 20 kHz is flat within  $\pm 0,5$  dB.

02/26/93

Figure 8-2 — Sound Unweighted Filter (UNWTD Q-PEAK/UNWTD RMS)

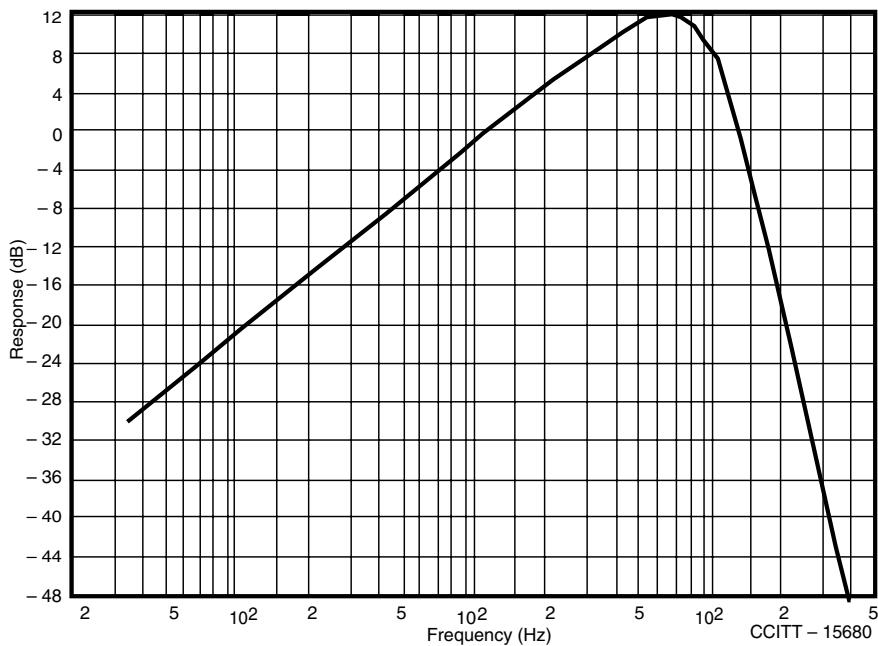

SOUND WEIGHTED CHARACTERISTIC

Frequency (Hz)	Design Loss (dB)	Frequency (Hz)	Design Loss (dB)
31,5	- 29,9 ± 2,0	6300	+ 12,2 ± 0
63	- 23,9 ± 1,4	7100	+ 12,0 ± 0,2
100	- 19,8 ± 1,0	8000	+ 11,4 ± 0,4
200	- 13,8 ± 0,85	9000	+ 10,1 ± 0,6
400	- 7,8 ± 0,7	10000	+ 8,1 ± 0,8
800	- 1,9 ± 0,55	12500	+ 0,0 ± 1,2
1000	0,0 ± 0,5	14000	- 5,3 ± 1,4
2000	+ 5,6 ± 0,5	16000	- 11,7 ± 1,65
3150	+ 9,0 ± 0,5	20000	- 22,2 ± 2,0
4000	+ 10,5 ± 0,5	31500	- 42,7 ± 2,8
5000	+ 11,7 ± 0,5		-

Figure 8-3 — Sound Weighted Filter (SWTD Q-PEAK / SWTD RMS)

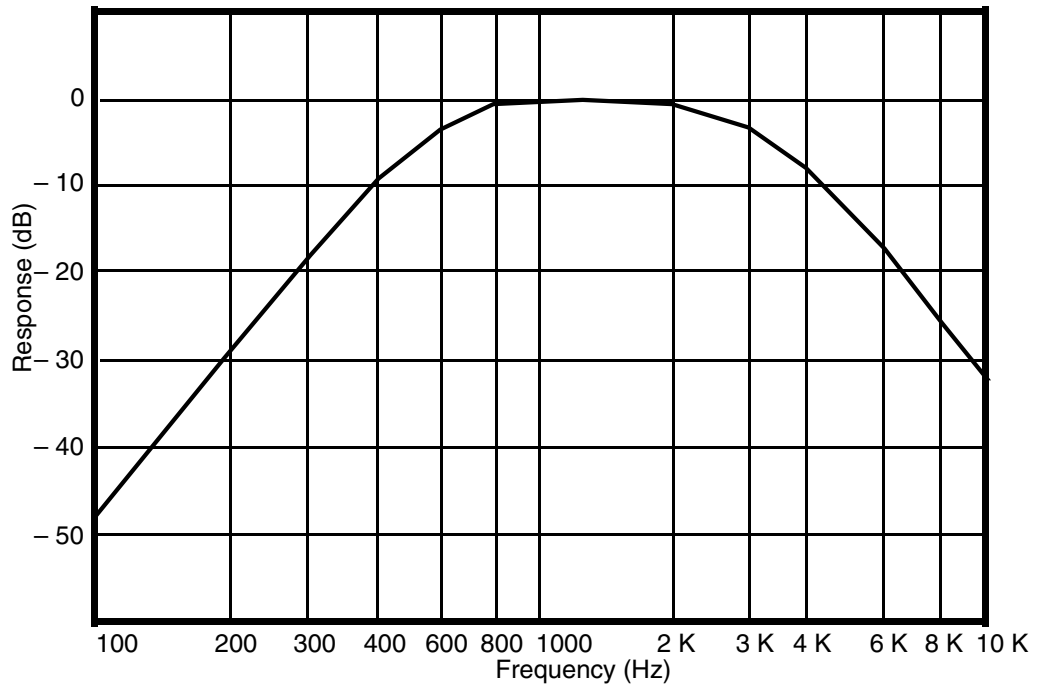

2 kHz FLAT WEIGHTING CHARACTERISTIC

Frequency (Hz)	Design Loss (dB)	Frequency (Hz)	Design Loss (dB)
100	-46,7	2000	- 0,4
200	-28,6	3000	- 3,0
300	-18,1	4000	- 8,2
400	-10,9	6000	-18,1
600	- 3,0	8000	-25,6
800	- 0,7	10000	-31,4
1300	0,0		

Figure 8-4 — 2 kHz Flat Filter (2 kHz FLAT)



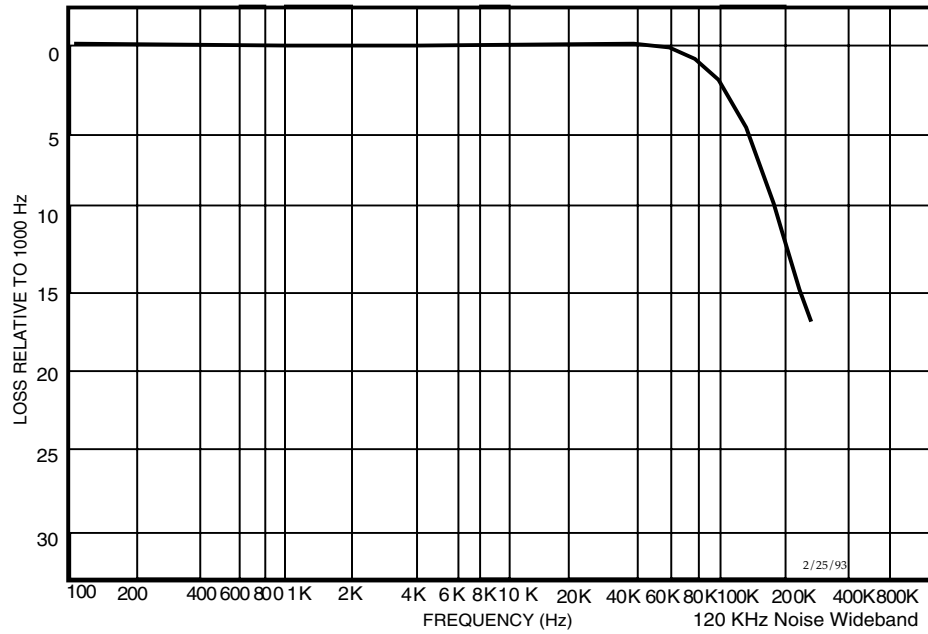

Figure 8-5 — Wideband 120 kHz Filter (WIDE —AM5e-120 Model)

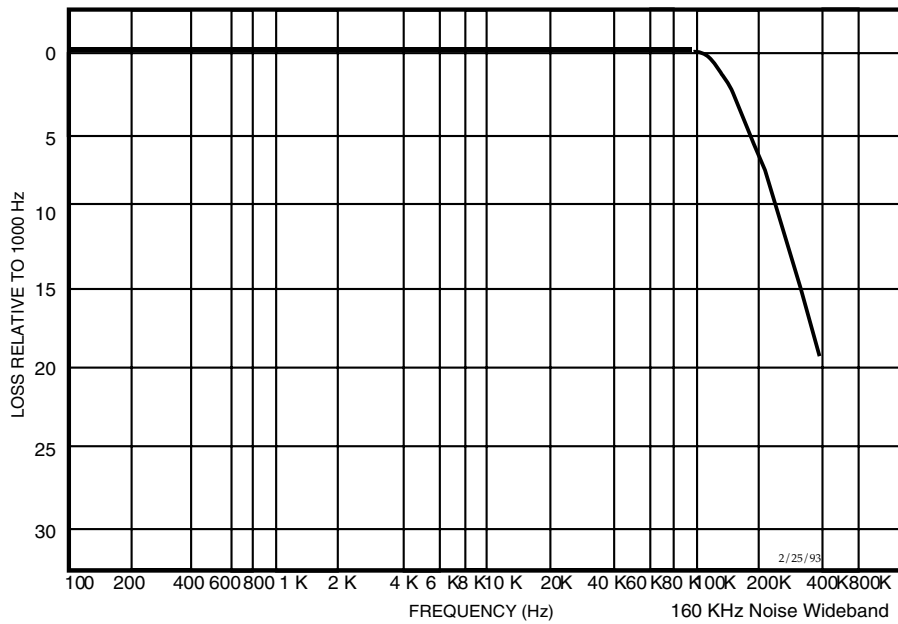

Figure 8-6 — Wideband 160 kHz Filter (WIDE — AM5e-200 Model)

## 8.2 60 Hz FILTER

The 60 Hz high-pass filter is provided to eliminate frequencies of 60 Hz or lower. Power line interference due to 60 Hz, 50 Hz or lower components may cause erratic readings on the display. Connect this filter to eliminate interference as follows:

1. Press right filter key so 60 Hz LED is lighted to connect the filter.
2. Press right filter key again to disconnect the filter; 60 Hz LED is not lighted.

## 8.3 L/F UNWTD MEASURE FILTER

When the MEASURE L/F UNWTD function is selected, a low-pass filter is connected to the front end of the measurement circuitry, effectively eliminating high-frequency components. The characteristics of this filter are the same as those shown in Figure 8-2.

*NOTE: As is the case with the MEASURE LEVEL FREQ function, average detection is used with the MEASURE L/F UNWTD function.*

None of the Noise Weighting Filters, previously described and illustrated in subsection 8.1, can be selected when L/F UNWTD or LEVEL FREQ functions are being used.

## 9. SEND FUNCTIONS AND PARAMETERS

The AM5(e) Classic contains a highly-flexible signal generator that is capable of generating a variety of test tones. The labels for the LEDs above the right SEND key are different for the AM5 Classic and the AM5e Classic. The front panel areas for SEND functions are shown below:



This section describes all the send functions and parameters in the order they are selected by each press of the SEND keys. Unless otherwise specified, the descriptions apply to both the AM5 Classic and the AM5e Classic. Views of the LED indicators and displays showing typical readings are provided. A lighted LED is shown by shading, as shown by above defaults.

If the LINE selection is 4W, 2W, or 2W +2.16 $\mu$ f, the signal generator will output from the TX/2W jack (or T and R terminals). If the LINE selection is 4W REVERSE, the signal generator will output from the RX jack (or T1 and R1 terminals). For any LINE selection, the SEND impedance is set by the left TX/2W key. (Refer to sub-sections 5.2.1 through 5.2.7 and 5.3 for more details)

The DIAL selection (sub-section 5.2.5) will disconnect the signal generator function and permit the operator to substitute a handset for dialing a remote number, talking, or listening. DIAL may also be used to provide an "Open" function (sub-section 9.7).

SEND functions are displayed by pressing the DISPLAY key so that the SEND indicator is lighted (sub-section 3.3.9).

The loudspeaker is connected to the SEND functions when the MONITOR switch is in the TX position (sub-sections 3.3.7 and 3.3.8).

The left SEND key is a toggle on/off selection of one of the functions above it (sub-sections 9.1 through 9.4).

The middle SEND key toggles on/off the Signalling Frequency lockout (SF SKIP) to prevent transmission of frequencies in the SF SKIP range (sub-section 9.5) by any of the left key functions.

The right SEND key selects or sends four fixed frequencies that are set by default to the frequencies labelled on the panel. These frequencies may be changed (sub-section 9.6).

**9.1 NO-SIGNAL, TERMINATED (QUIET)**



The basic QUIET function is no output from the signal generator. Internally, the generator is disconnected and the line is quiet-terminated by the TX/2W impedance described in sub-sections 5.2.6 and 5.3. While QUIET is selected, the Level ("LEVL") parameter of all signal generator functions may be set, and the FREQUENCIES for F1, F2, F3 and F4 may be changed.

*CAUTION: Level may be changed when any SEND function is selected; however, this is for convenience to permit level change while a signal is being output. The LEVL parameter will apply to all SEND functions.*

**9.1.1 QUIET Data:** The display of QUIET data is all dashes, and the SEND LED is lighted as shown in Figure 9-1.

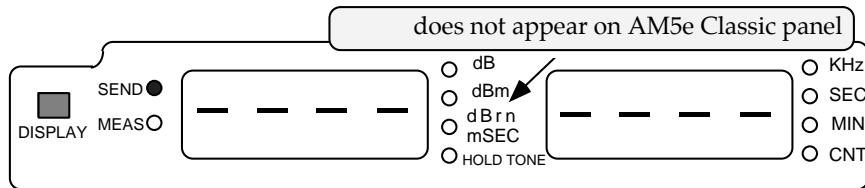

Figure 9-1 — Send QUIET Data Display

**9.1.2 QUIET Parameters:** The QUIET parameter displays and default values (for an AM5 Classic) are shown in Figure 9-2. To select the parameters, press the PARAMeter SElect key. Each press of the key will display another parameter. The quiet parameters and their abbreviations, range and default values follow:

Parameter Description	Display Abbreviation	Low	<default>	High	LED
Level for <b>all</b> SEND functions	LEVL	- 50.0	<00.0>	13.0	dBm
Frequencies for right SEND key selections.  (High-limit is 200.0 kHz for AM5(e) Classic-200)	F1	0.020	<0.404> * <0.304>	120.0	kHz
	F2	0.020	<1.004> * <1.004>	120.0	
	F3	0.020	<2.804> * <2.004>	120.0	
	F4	0.020	<2.713> * <3.004> * for AM5e Classic	120.0	
Version	VEr	101A or latest (display only)		none	

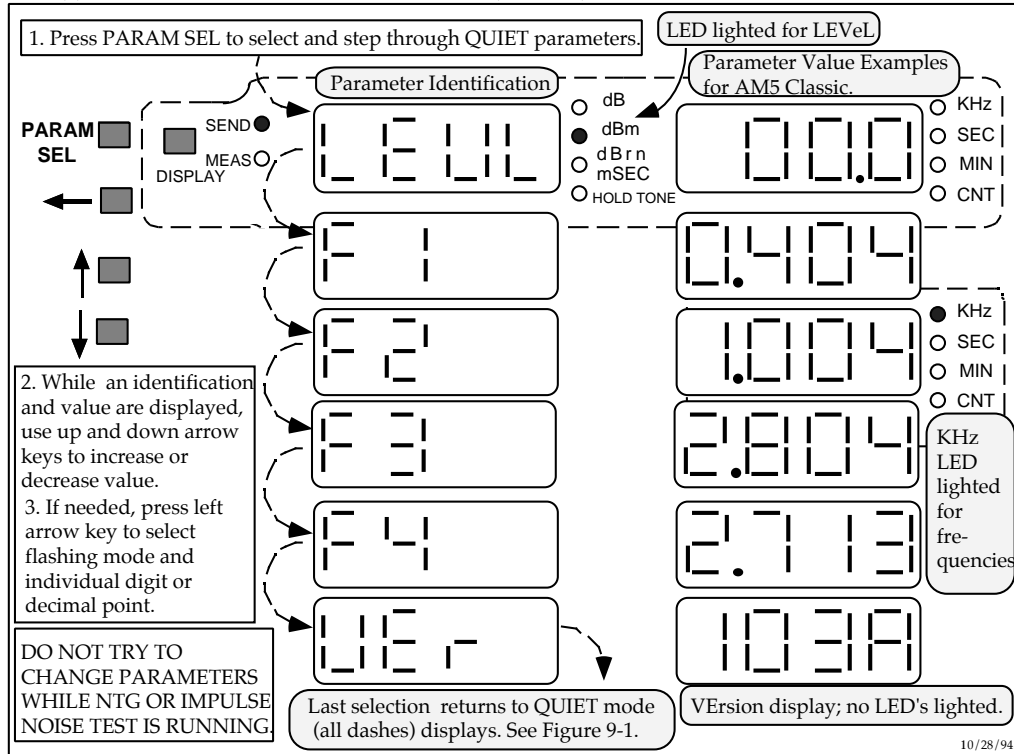

Figure 9-2 — Send QUIET Parameter Displays

Use the left-arrow key to select a digit or decimal point and/or use the up and down arrow key to increase or decrease a digit or move the decimal point (see 3.3.14 for general information on arrow keys). For more details on setting frequency refer to 9.3.2.

**9.2 1004 Hz TONE (1004 Hz)**



To select a continuous 1004 Hz sine wave output, press the left SEND key so that 1004 Hz indicator is lighted. The signal generator then outputs a continuous 1004 Hz sine wave. Figure 9-3 shows the 1004Hz data display and the level parameter. Level is adjustable after being selected with the PARAMeter SElect key.

This function is useful for tests which require that a hold tone be sent to a remotely-located AM5(e) Classic. The level should be set so that at least -40 dBm is received at the remote-end.

The AM5(e) receive circuits provide a notch filter and light the HOLD TONE indicator when one of the MEASURE Functions that requires a received 1004 Hz tone is selected (S/N RATIO, IMP N W/T, NOISE W/T). For details refer to sub-sections 6.4, 6.6, and 6.7.

- 9.2.1 1004 Hz Data Display:** Figure 9-3 shows a -20 dBm level and 1004 Hz frequency displayed in the left and right display windows. This figure also shows the level (LEVL) parameter which may be set with the PARAMeter SElect key.
- 9.2.2 1004 Hz Parameter Display/Adjustment:** Figure 9-3 also shows the level parameter. The level is common to all SEND functions and is shown at a setting of -20 dBm. The display of level permits changes to be made while the signal is being sent. **Level changes affect all SEND functions.**

### 9.3 VARIABLE FREQUENCY GENERATOR (VAR Hz)



The Variable Frequency generator can be selected to send out any frequency within the range of the AM5(e) unit. This generator is very flexible and may be adjusted while a signal is being sent. Both level (LEVL) and FREquency may be set.

- 9.3.1 VAR Hz Data Display:** Figure 9-4 shows a 10 dBm level and 1.004 kHz frequency display. The figure also shows the level and frequency parameter displays. Both level (LEVL) and FREquency may be set after they have been displayed with the PARAMeter SElect key.
- 9.3.2 VAR Hz Parameter Display/Adjustment:** The level and frequency parameters (Figure 9-4) are displayed in sequence as the PARAMeter SElect/EnTeR key is pressed, then the data is displayed again.

While either parameter is displayed, it may be adjusted with the arrow keys. The change in generator level or frequency occurs immediately; it is not necessary to step to the next parameter or data.

The FREquency change with the up- or down-arrow keys (without using the flashing-digit mode) and the display depend on the range being set, and whether the key is pressed momentarily or pressed-and-held for greater than one (1) second. A value from each FREquency range is illustrated in Figure 9-4. The following table shows the fixed leading- zeroes, decimal point, and the digit (d) which can be changed for each range. To change any single digit of frequency, press the left-arrow key then use the up- or down-arrow keys in the flashing-digit mode.

Frequency Range	Press Once	Press-and-Hold
20 Hz to 99 Hz	10 Hz (0.0dx)	100 Hz (into next range)
100 Hz to 999 Hz	10 Hz (0.xdx)	100 Hz (0.dxx)
1000 Hz to 9999 Hz	10 Hz (x.xdx)	100 Hz (x.dxx)
10 kHz to 99.99 kHz	10 Hz (xx.xd)	100 Hz (xx.dx)
100 kHz to 120 kHz (200 kHz for -200 models)	100 Hz (xxx.d)	1 KHz (xxd.x)

*NOTE: If a value is set outside the range of the unit, it will be automatically set to the closest limit after PARAMeter SElect is pressed to display the data.*

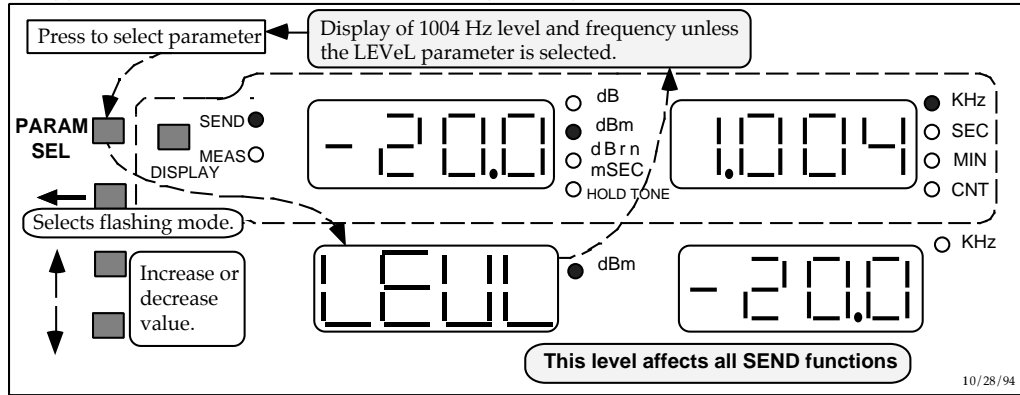

Figure 9-3 — Send 1004 Hz Data and Parameter Displays

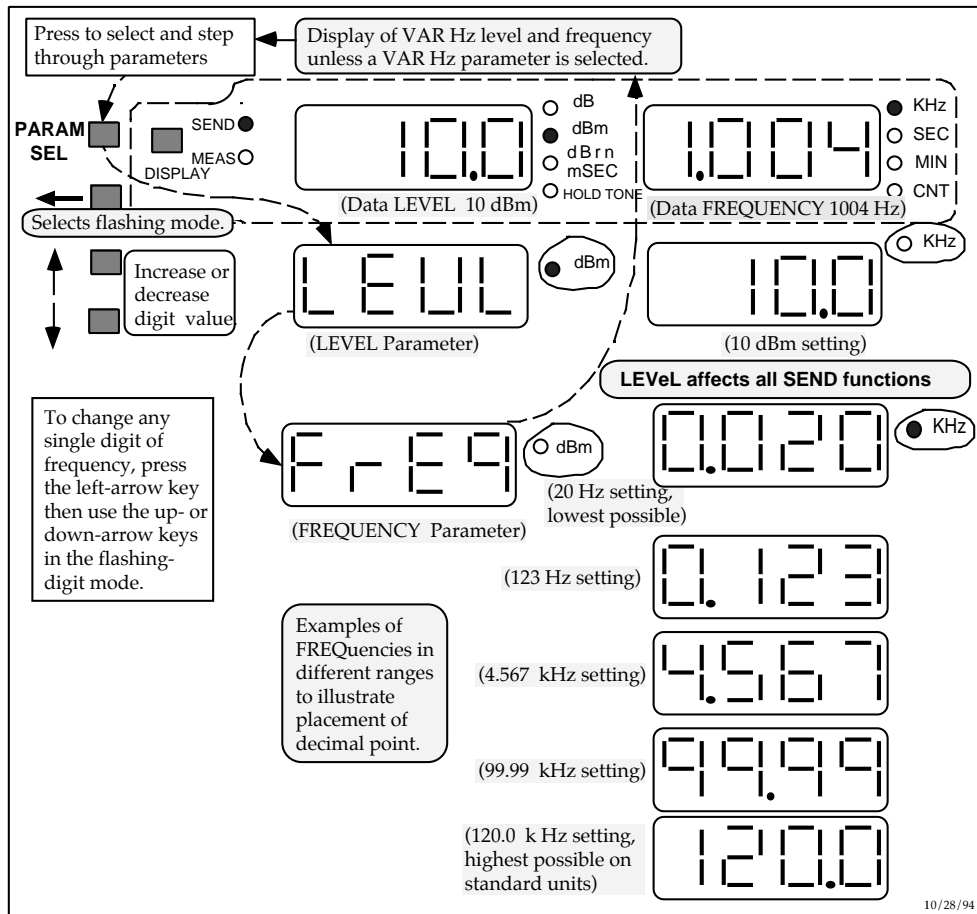

Figure 9-4 — Send VARIABLE Hz Data and Parameter Displays

#### 9.4 SWEEP GENERATOR (SWEEP)10/94 /28 (Fri) 17:03 to here.

When SWEEP is selected, the signal generator steps through a series of frequencies. The programmed defaults starts the sweep at 304 Hz and increases in 100 Hz steps at a three (3) -second rate until 3.004 kHz. When the 3.004 kHz stop frequency is reached, the sweep immediately begins again, unless the zero delay is changed.

To provide an audible reference to the beginning and end of the sweep, a delay may be programmed so that the first and last tone will have a longer duration than the other tones.

The SWEEP function is useful for performing step-frequency tests to measure the response/bandwidth of a circuit. A slow sweep rate within the voice-frequency range allows an operator at the far end to note the levels as the tones are received.

**9.4.1 SWEEP Data Display:** Figure 9-5 shows a 0 dBm level and 1.904 kHz frequency display. The frequency will be increasing in steps while the data is displayed. The figure also shows the default parameter displays.

If the SF SKIP function (see 9.5) is turned ON, frequencies in the rejection band of the SF SKIP cannot be displayed or output if they are in the range of a SWEEP.

Any of the single tones (F1 through F4) may be selected or sent during the sweep (see 9.6). The sweep is interrupted while the single tone is sent. When the tone is stopped, the sweep begins again at the start frequency.

**9.4.2 SWEEP Parameter Display/Adjustment:** The level, start frequency, stop frequency, step frequency, and delay parameters (Figure 9-5) are displayed in sequence as the PARAMeter SElect/EnTeR key is pressed, then the data is displayed again. The following table shows the abbreviations, range, and default values for the SWEEP parameters:

Parameter Description	Display Abbreviation	Low	<default>	High	LED
Level for all SEND functions	LEVL	- 50.0	<00.0>	13.0	dBm
Start Frequency	STrT	0.020	<0.304>	120.0	kHz
Stop Frequency	SToP	0.020	<3.004>	120.0	
Step Frequency (High-limit is 200.0 kHz for AM5(e) Classic-200)	STEP	0.020	<0.100>  200.0	120.0	
Sweep Rate	rATE	000.1	<003.0>	999.9	SEC
Delay at start and stop Frequency	dLAY	000.0	<000.0>	999.9	SEC

*NOTE: The finest resolution of sweep rate and delay is .24 seconds (based on change over frequency) Due to this fact, the AM5(e) Classic will round the entered value to the nearest 0.24 second*



Parameter changes take effect as soon as they are made. If a start or stop frequency is set within the SF SKIP rejection band (see 9.5), the start or stop frequency will be moved to the lower or upper frequency limit of the rejection band (depending on which is closest) when SF SKIP is turned on. (Frequencies are not readjusted after SF SKIP is turned off.).

Frequency steps that fall within the SF SKIP rejection band are never sent if SF SKIP is on. They will be sent as soon as SF SKIP is turned off.

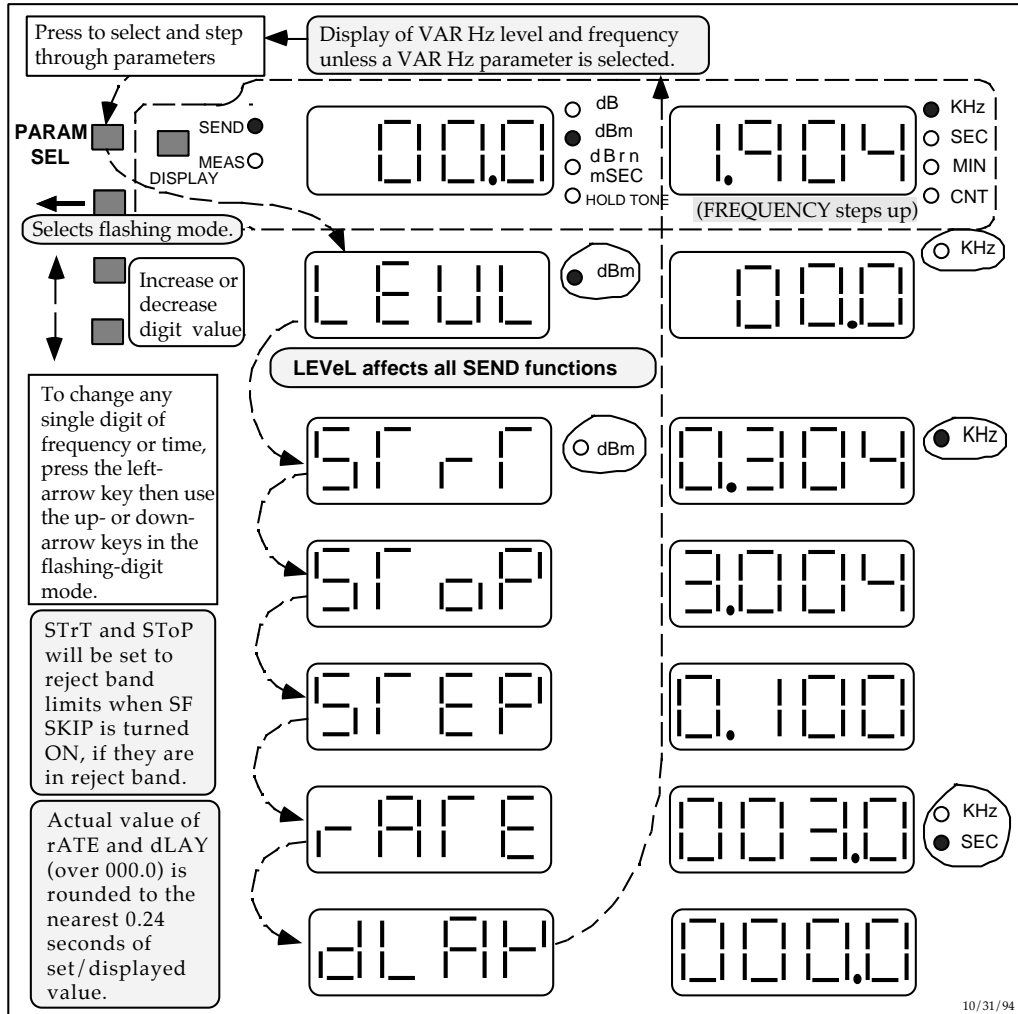

Figure 9-5 — Send SWEEP Data and Parameter Display

## 9.5 SIGNALLING FREQUENCY SKIP (SF SKIP)



The SF SKIP is used to avoid sending tones in the “signalling frequency” band that could interfere with other equipment. SF SKIP is an ON/OFF toggle that affects the VAR Hz or SWEEP functions.

When SF SKIP is ON (LED lighted), the VAR Hz generator cannot be set to send frequencies in the rejection band. If a frequency is set in the band while SF is OFF, the frequency will be reset to the upper or lower limit of the rejection band when SF SKIP is turned ON. The frequency will not be reset when SF SKIP is turned OFF.

When SF SKIP is ON, the SWEEP generator start or stop frequencies cannot be set (or remain) within the rejection band. If the SWEEP range includes the SF SKIP rejection band, those frequencies will not be output. The rejection band is different for the AM5 and AM5e Classic.

QUIET Frequencies (F1, F2, F3, or F4) can be set within the rejection band when SF SKIP is ON. This allows the user to momentarily override the SF SKIP band to send control tones.

**9.5.1 SF SKIP Rejection for AM5 Classic:** The rejection band for the AM5 Classic is 2450 Hz through 2750 Hz to conform to IEEE standards.

**9.5.2 SF SKIP Rejection for AM5e Classic:** The rejection band for the AM5e Classic is 2130 Hz through 2430Hz to conform to CCITT standards.

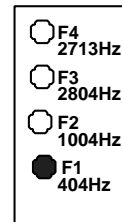

AM5 Classic

## 9.6 SINGLE FREQUENCY TONES (F1, F2, F3, F4)

**9.6.1 General Information:** The single-frequency tones are selected by pressing the right SEND key until the LED for the tone is flashing. Once the LED is flashing, the tone may be output by pressing and holding the right SEND key for three seconds until the LED is steady. The tone is stopped by pressing and releasing the SEND key. The single-tone over-rides any other SEND function. If a SWEEP frequency is being generated, the SWEEP is reset to its starting frequency after the tone is stopped.

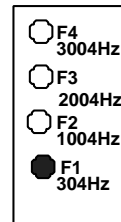

AM5eClassic

**9.6.2** The single-tone may also be over-riden by pressing any of the left SEND keys. For example, if an F4 tone is being output, shifting from QUIET to 1004Hz will automatically stop the F4 tone and send the 1004 Hz tone.

The frequency labels on the front panel are the defaults that have been chosen for various control or test purposes and are different for the AM5 and AM5e Classic. Frequencies and level may be changed when QUIET is selected, refer to 9.1.

One use of a single-frequency tone is to command a remote device into loopback mode. This is described in the next sub-section

**10. AM5 and AM5e CLASSIC SPECIFICATIONS**

This Section consists of the specifications for all models of the AM5 Classic. It is in a tabular format (beginning on Page 10-2) , and should be consulted for an overview of each model's capabilities. A left arrow (" <——") indicates specifications identical to previous columns.

Technical Specifications (Sheet 1 of 5)

TRANSMITTER LEVEL/FREQUENCY			AM5/AM5e Classic-200 Models																																		
Specification	AM5 Classic-120	AM5e Classic-120																																			
VAR Hz Mode	20Hz to 120kHz in 10Hz or 100Hz steps	<-----	20Hz to 200kHz in 10Hz or 100Hz steps																																		
1004Hz Mode	1004Hz Fixed	<-----	<-----																																		
F1	404Hz	304Hz	<-----																																		
F2	1004Hz	1004Hz	<-----																																		
F3	2804Hz	2004Hz	<-----																																		
F4 (F1 - F4 Freq. may be reset.)	2713Hz	3004Hz	<-----																																		
Sweep Mode Start Frequency	20Hz to 120kHz	<-----	20Hz to 200kHz																																		
Stop Frequency	20Hz to 120kHz	<-----	20Hz to 200kHz																																		
Step Size	1Hz to 119.9kHz	<-----	1Hz to 199.9Hz																																		
Step Dwell	1/4 second to 999.9 seconds.	<-----	<-----																																		
Inter-Sweep delay	0, 1/4 second to 999.9 seconds.	<-----	<-----																																		
SF SKIP	2450 to 2750Hz	2130 to 2430Hz	<-----																																		
Frequency Accuracy	± .01%	<-----	<-----																																		
Level Range Max. output is +13dBm at 600 Ω, +10dBm at 900 Ω, +3dBm at 135 or 150 Ω Impedance	-50dBm to +13dBm  (All modes have common level setting)	<-----	<-----																																		
Resolution	.1dB	<-----	<-----																																		
Accuracy Accuracy not specified below 400Hz with 135 or 150 Ω impedance.	<table border="1"> <thead> <tr> <th rowspan="2">dBm</th> <th colspan="3">20 200 20 120</th> <th colspan="3">20 200 20 150 200</th> </tr> <tr> <th>Hz</th> <th>kHz</th> <th></th> <th>Hz</th> <th>kHz</th> <th></th> </tr> </thead> <tbody> <tr> <td>+13</td> <td>± .25</td> <td>± .1</td> <td>± .25</td> <td>± .25</td> <td>± .1</td> <td>± .25 ± .5</td> </tr> <tr> <td>-40</td> <td>± .5</td> <td>± .5</td> <td>± .5</td> <td>± .5</td> <td>± .5</td> <td>± .5 ± 1.0</td> </tr> <tr> <td>-50</td> <td colspan="3" style="text-align: center;">-120 Models</td> <td colspan="3" style="text-align: center;">-200 Models</td> </tr> </tbody> </table>			dBm	20 200 20 120			20 200 20 150 200			Hz	kHz		Hz	kHz		+13	± .25	± .1	± .25	± .25	± .1	± .25 ± .5	-40	± .5	± .5	± .5	± .5	± .5	± .5 ± 1.0	-50	-120 Models			-200 Models		
dBm	20 200 20 120				20 200 20 150 200																																
	Hz	kHz		Hz	kHz																																
+13	± .25	± .1	± .25	± .25	± .1	± .25 ± .5																															
-40	± .5	± .5	± .5	± .5	± .5	± .5 ± 1.0																															
-50	-120 Models			-200 Models																																	

Technical Specifications (Sheet 2 of 5)

RECEIVER LEVEL/FREQUENCY																											
Specification	AM5 Classic-120																										
Specification	AM5 Classic-120	AM5e Classic-120	AM5/AM5e Classic-200 Models																								
<b>Level Range</b>	-64.9 to +13dBm	<table border="1"> <tr> <td>&lt; +10dBm</td> <td>20 Hz</td> <td>200 Hz</td> <td>20 kHz</td> <td>150 kHz</td> <td>200 kHz</td> </tr> <tr> <td>-40dBm</td> <td>± 0.5</td> <td>± 0.2 *</td> <td>± 0.5</td> <td>± 1.0</td> <td></td> </tr> <tr> <td>-45dBm</td> <td>± 0.5</td> <td>± 0.2</td> <td>± 0.5</td> <td>± 2.0</td> <td></td> </tr> <tr> <td>-65dBm</td> <td>± 1.0</td> <td>± 1.0</td> <td>± 1.0</td> <td>± 3.0</td> <td></td> </tr> </table>	< +10dBm	20 Hz	200 Hz	20 kHz	150 kHz	200 kHz	-40dBm	± 0.5	± 0.2 *	± 0.5	± 1.0		-45dBm	± 0.5	± 0.2	± 0.5	± 2.0		-65dBm	± 1.0	± 1.0	± 1.0	± 3.0		
< +10dBm	20 Hz	200 Hz	20 kHz	150 kHz	200 kHz																						
-40dBm	± 0.5	± 0.2 *	± 0.5	± 1.0																							
-45dBm	± 0.5	± 0.2	± 0.5	± 2.0																							
-65dBm	± 1.0	± 1.0	± 1.0	± 3.0																							
<b>Resolution</b>	<table border="1"> <tr> <td>+13</td> <td>20</td> <td>200</td> <td>20</td> <td>120</td> </tr> <tr> <td></td> <td>Hz</td> <td>Hz</td> <td>kHz</td> <td>kHz</td> </tr> <tr> <td>-50</td> <td>± .5</td> <td>± .2*</td> <td>± .5</td> <td></td> </tr> <tr> <td>-65</td> <td>± 1.0</td> <td>± 1.0</td> <td>± 1.0</td> <td></td> </tr> </table> <p>-120 Models</p>	+13	20	200	20	120		Hz	Hz	kHz	kHz	-50	± .5	± .2*	± .5		-65	± 1.0	± 1.0	± 1.0		<-----	<-----				
+13	20	200	20	120																							
	Hz	Hz	kHz	kHz																							
-50	± .5	± .2*	± .5																								
-65	± 1.0	± 1.0	± 1.0																								
<b>Accuracy</b>	.1dB																										
<b>Accuracy</b>	* ± .1dB @ 1004 to 1020Hz @ 0 to -20dBm																										
Accuracy is not specified below 400Hz with 135 or 150 Ω impedance.																											
<b>Detector Type</b>	Average	<-----	<-----																								
<b>Filters</b>	120kHz Low Pass 15kHz Low Pass 60Hz High Pass	120kHz Low Pass Sound UnWTD (J.16) 60Hz High Pass	200kHz Low Pass <----- <-----																								
<b>Frequency Range</b>	20Hz to 120KHz	<-----	20Hz to 200kHz																								
<b>Resolution/Accuracy</b>	± 0.01 % of reading ± 1 count	<-----	<-----																								
<b>Sensitivity</b>	-55 to +13dBm with S/N Ratio > 20dB	<-----	<-----																								

## Technical Specifications (Sheet 3 of 5)

<b>IDLE LINE NOISE</b>			AM5/AM5e Classic-200 Models
Specification	AM5 Classic-120	AM5e Classic-120	
Transmitter	QUIET termination	<————	<————
Receiver Range	10 to 99dBm (20 to 99dBm @ 135/150 Ω)	-80 to +9dBm (-70 to +9dBm @ 135/150 Ω)	<————
Resolution	1dB	<————	<————
Accuracy	± 1dB @ 20 to 100dBm ± 2dB @ 10 to 20dBm (± 1dB CMMSG filter)	± 1dB @ -70 to +10dBm ± 2dB @ -80 to -70dBm (± dB PSHO filter)	<————
Filter	120kHz Low Pass C-MeSsaGe Program 3kHz Flat 15kHz Flat 50kBit 60Hz High Pass	120kHz Low Pass PSopHOMetric [P.53] Sound UNWTD [J.16] Sound WTD [J.16] 2kHz Flat (750 to 2300Hz) [Q.71] 60Hz High Pass	160kHz Low Pass  <————
Detector	RMS	RMS or Quasi-Peak (Selected with filters [J.16])	<————
Transmitter	<b>NOTCH NOISE (NOISE WITH TONE)</b>		
	1004Hz (Holding Tone)	<————	<————
Notch Filter Rejection Notch	995 to 1025Hz >50dB	<————	<————
Automatic Filter (if no other filter selected)	<b>Other Specifications are same as Idle Line</b>		<————
	CMMSG	PSHO	
<b>NOISE TO GROUND (NTG)</b>			
Transmitter	QUIET termination	<————	<————
Receiver Range	40 to 129dBm	-50 to +39dBm	<————
Resolution	1dB	<————	<————
Accuracy	± 1.5dB	<————	<————
Filters and Detectors	<b>Same as Idle Line Noise</b>		<————

## Technical Specifications (Sheet 4 of 5)

SIGNAL TO NOISE RATIO		AM5e Classic-120	AM5/AM5e Classic-200 Models
Specification	AM5 Classic-120		
Transmitter	QUIET termination	<————	<————
Receiver			
Signal Range	-40 to +10dBm	<————	<————
Noise Range	10 to 70dBm (20 to 70dBm @ 135/150 Ω)	-80 to -20dBm (-70 to -20dBm @ 135/150 Ω)	<————
Ratio Range	10 to 50dB	<————	<————
Accuracy	± 1dB @ 10 to 40dB ± 2dB @ 40 to 45dB ± 3dB @ 45 to 50dB	<————	<————
		Noise below -70dBm reduces accuracy to ±2dB except when using PSHO filter.	<————
IMPULSE NOISE (3 LEVEL) PER IEEE 743 AND CCITT 0.71		<————	<————
Transmitter	QUIET termination		
Receiver			
Minimum Threshold	30dBm	-60dBm	<————
Threshold Difference	2, 3, 4 or 6dB	<————	<————
Threshold Accuracy	± 1dB	<————	<————
Timer	.1 minute to 999.9 minutes or Continuous	<————	<————
Maximum Count (3 Counters)	high 9999 mid 9999 low 9999	<————	<————
Dead Time	1 to 255ms (125ms preset)	<————	<————

## Technical Specifications (Sheet 5 of 5)

GENERAL SPECIFICATIONS			AM5/AM5e Classic-200 Models
Specification	AM5 Classic-120	AM5e Classic-120	
<b>Input</b>	4-Wire 4-Wire Reverse 2-Wire 2-Wire with 2.16 $\mu$ f Termination	<————	<————
<b>Receive Impedance</b>	135 $\Omega$ , 150 $\Omega$ , 600 $\Omega$ , 900 $\Omega$ , 1200 $\Omega$	<————	<————
<b>High Impedance Bridging</b>	50,000 $\Omega$ Bridging Loss is less than . 2dB	<————	<————
<b>Transmit Source Impedance</b>	135 $\Omega$ , 150 $\Omega$ , 600 $\Omega$ , 900 $\Omega$ , 1200 $\Omega$	<————	<————
<b>DC Blocking</b>	200 VDC	<————	<————
<b>Balance</b>	> 90dB @ 50Hz – 120Hz. Decreases 6dB/octave above 120Hz	<————	<————
<b>Hold Circuit</b> Independent Transmit and Receive	DC = 200 $\Omega$ AC = > 20,000 $\Omega$	<————	<————
<b>Monitor</b> Built-in Speaker/Volume Control Selection	Transmit Receive Measure	<————	<————
<b>Power</b>	115 VAC or 230 VAC 50/60Hz	<————	<————
<b>Weight with batteries</b>	Optional Internal Sealed Lead-Acid Battery with Recharger for all		
	6 lbs 10 lbs	2.72 kg 4.54 kg	<————
<b>Dimensions</b> Width Height Depth	8.3 in. 3.5 in. 12.1 in.	210 mm 89 mm 307 mm	<————
<b>Operating Temperature</b>	0 to 50 Degrees Celsius	<————	<————
<b>Line Connections</b>	Dual Miniature Phone Jacks (mate with ADC PJ777 or Switchcraft TT253) on front panel. Screw Terminals on rear panel. Optional front panel "Siemens" jacks.		



## **11. WARRANTY, SERVICE AND CALIBRATION**

### **11.1 WARRANTY**

AMERITEC Corporation warrants that its electronic instrument products are manufactured to the highest commercial standards and are free from any defects in material or workmanship.

For a period of one (1) year from shipment, AMERITEC will repair, without charge to the original purchaser, any unit which upon inspection by AMERITEC proves to be defective.

This warranty is the sole warranty offered by AMERITEC and is in lieu of all other obligations or liabilities, including claims of consequential damage; however, an **EXTENDED WARRANTY PLAN** may be purchased. For information contact an Ameritec Sales Representative.

### **11.2 SERVICE POLICY**

AMERITEC products are designed with plug-in printed circuit boards and modular assemblies. Once a problem is localized, service is accomplished by PC board (or module) replacement.

### **11.3 CALIBRATION POLICY**

All AMERITEC products are manufactured to commercial standards and are calibrated with equipment traceable to NIST (National Institute of Standards and Technology). With the exception of component failures or abuse, AMERITEC instruments are designed to maintain compliance with their published specifications throughout their service life.

While periodic calibration verification is normally not required, in critical applications it is recommended that verification be accomplished annually.

Calibration verification is most efficiently accomplished by return of the equipment to the AMERITEC factory where specialized test equipment is used. Field calibration verification is not supported by AMERITEC.

**11.4 RETURN OF UNIT**

In the event of a malfunction, call or write to the AMERITEC factory and obtain a return authorization number. Return the unit to AMERITEC freight prepaid with a note (in-warranty repair) or a Purchase Order for the repair (out-of-warranty repair) listing the following information:

- Return authorization number from AMERITEC.
- Return shipment address of purchaser.
- Name and telephone number of person at purchaser's location familiar with the problem.
- Brief description of problem (include any printouts that may have a bearing on the problem, if possible).
- Terms of payment for repair costs (out-of-warranty unit).

The unit will be repaired and returned freight-prepaid for units in warranty and freight-collect for units out-of-warranty. As stated above, a Purchase Order to cover the cost of repair must accompany any out-of-warranty return of the unit to AMERITEC.



760 Arrow Grand Circle  
Covina, CA 91722 USA  
TEL (626) 915-5441  
FAX (626) 915-7181  
[www.ameritec.com](http://www.ameritec.com)  
[info@ameritec.com](mailto:info@ameritec.com)

We made our name with  
American Technology

ISO 9001 Certified Company

**A.1. AM5 *Classic* APPENDIX****A.1.1. SCOPE**

Field Calibration and validation procedures AM5-C-120, and AM5-EC-120, and AM5-C-200 with software versions **105A** or later. Refer to the AM5-*Classic* Instruction Manual Section 4.6, Calibration Procedure, to help identify the software version the unit currently has installed.

**A.1.2. EQUIPMENT REQUIRED**

1. A highly accurate AC voltmeter (up to 4 decimal places, +/- 0.1% at 1 KHz)
2. Bantam to Minigator and/or Bantam to Bantam Cables.
3. A 600 ohm load resistor, accurate to 1% tolerance (1/4 watt).

**A.1.3. CALIBRATION PROCEDURE****TRANSMIT AND RECEIVE CALIBRATION**

1. Remove all input leads.
2. Connect T1 and R1 leads of the AM5-*Classic* of either the front right bantam jack or rear terminal screws to the AC Voltmeter.
3. Set the voltmeter to measure AC voltage.
4. Power up the unit to be calibrated and verify it is in [SEND] and [QUIET] modes.
5. Press [PARAM SEL] key until the Software Version number appears.
6. Press and hold down [START/STOP] key for 3 seconds until “**FULL CAL?**” appears on the screen.
7. Press the [ENTER] key (left arrow pointing key) to start full calibration.

**Note:** To abort “**FULL CAL?**” press any key other than ENTER].

8. The display will read V1 on the left and 3850 on the right. 1004 Hz LED will come on.
9. Enter the total voltage in millivolts, by using the UP/DOWN arrow key to increase/decrease the V1 value (or hold down the key to go faster). Voltage should be larger than 3431 mV and smaller than 4320 mV. Press the [ENTER] key. Any voltage entered outside the lower and upper ranges will display “**DATA ERROR**” and any key pressed will abort calibration.

**Note:** If the calibration procedure is aborted before completion, power the unit off, and then on again. The unit display should read “**FULL CAL?**”. Press [ENTER] key and complete steps 9 through 12.

Repeat Steps 8 and 10 until data for V2 through V9 voltages have been entered. The minimum and maximum of readings are as follows.

	<u>DISPLAY</u>	<u>VALID RANGES</u>	
		<u>lower</u>	<u>upper</u>
V1	----	3431 mV	4320 mV
V2	----	859.2 mV	1082 mV
V3	----	632.8 mV	796.5 mV
V4	----	158.7 mV	199.6 mV

The rest of the voltages should be entered as the AC voltmeter reads in millivolts \*(times) 10. Your measurements should be within the below ranges.

V5	----	1587 mV	1996 mV
V6	----	109.6 mV	137.9 mV
V7	----	282.5 mV	355.6 mV
V8	----	206.8 mV	260.2 mV
V9	----	54.13 mV	68.13 mV

10. After V9 is entered, display will be blank on the left and read “**CAL?**” on the right.
11. Disconnect the AC voltmeter leads from the AM5-*Classic* being calibrated. Press [ENTER] key. The unit will begin to calibrate itself. This process takes approximately 4 minutes. After calibration is completed, unit goes to **AUX** mode, displaying “**UNDR**”. Now Auto Calibration must be conducted.

**A.1.4. VALIDATION PROCEDURE**

1. Connect the Bantam to Minigator cable from the AM5-Classic (unit under test) "4W SEND" to the 600 ohm load resistor.
2. Connect the AC volt meter leads to the 600 ohm resistor. See the drawing below.

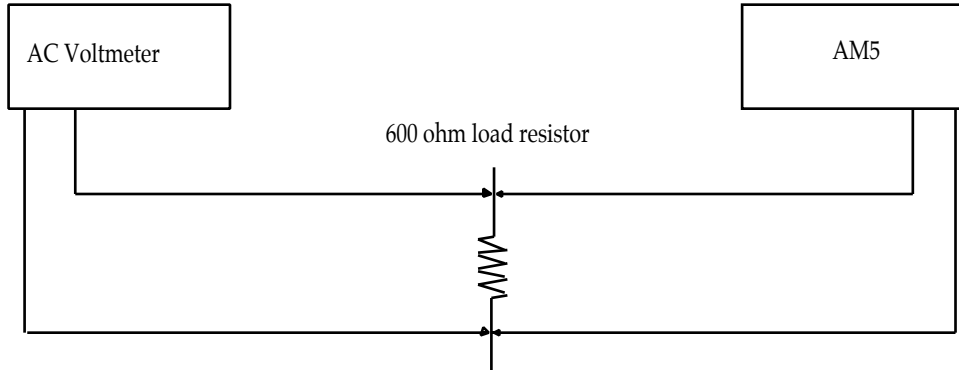

3. Set the voltmeter to measure AC voltage.
4. Program the AM5-Classic to 4W, 600 Ohm Term and transmit 1004 Hz at different levels. Read AC voltage on the Voltmeter and make sure readings correspond to the values below:

		Low	High
Transmit 1004 Hz @	+5 dBm	1.363 V	1.393 V
	-10 dBm	242.2 mV	247.70 mV
	-25 dBm	43.70 mV	44.40 mV
	-40 dBm	7.66 mV	7.83 mV
	-50 dBm	2.32 mV	2.59 mV

**Note:** Any reading which does not fall within the above values indicates that the unit is in need of re-calibration. Refer to the Calibration Procedure.

5. Refer to the Self-Test Instructions in the User Manual, Ameritec Part No. 18-0047, to verify proper operation of the unit. If the unit fails Calibration, Validation of Calibration, or the Self Test Instructions twice, the unit should be sent to Ameritec for repair.

*(END OF APPENDIX)*

## INDEX FOR AM5(e) CLASSIC

## CAUTIONS

inside front cover, 2-1, 3-1, 3-5, 3-15, 3-16, 9-2

## NOTES

3-1, 3-5, 3-6, 3-8, 3-11, 3-12, 4-1, 4-3, 4-5 >  
4-7, 5-1, 5-3 > 5-9, 6-2, 6-7 > 6-9, 6-10, 7-1 >  
7-5, 7-8, 8-1, 8-2, 8-7, 9-4, 9-6

## NUMERICAL INDEX

2-Wire Line Circuit Block Diagram	5-3	48-0047 cable	3-18, 5-1
2-Wire Testing	5-11	48-0048 cable	3-18, 5-1
		48-0062 cable	3-18, 5-1
2-wire circuits	3-5	50 kBit Filter	7-6
2-Wire Testing with Responder	5-11	50 K $\Omega$ bridging impedance	5-4, 5-7
2.16 $\mu$ f selection	5-3, 5-7	60 Hz FILTER	5-5, 7-8, 8-7
2W LED on	3-5	85-0076 19" Rack Mounting Kit	3-18
2W selection	5-3	85-0078 Protective Front Panel	3-18
		85-0233 19" Rack Mounting Shelf	3-18
4-wire circuits	3-5	87-0070 Padded Carrying Case	3-18
4-Wire End-to-End Testing Configuration	5-8	2 kHz Flat Filter (2 kHz FLAT)	8-5
4-Wire Line Circuit Block Diagram	5-2	3 kHz Low Pass Filter (3 kHz)	7-4
4-Wire Testing with Responder	5-10, 5-11	15 kHz Low Pass Filter (15 kHz)	7-5
		120 kHz Filter (WIDE)	7-7, 8-6
4W LED	3-5	160 kHz Filter (WIDE)	7-7, 8-6
4W REV LED	3-5	200 kHz designation plate	3-4
		135 $\Omega$	5-4
4W REVerse selection	5-2	150 $\Omega$	5-4
4W selection	5-2	200 $\Omega$ or less (DC path)	5-7
		600 $\Omega$	5-4
19" Rack Mounting	3-18	900 $\Omega$	5-4
24-0017 Batteries	3-17	1200 $\Omega$	5-4
25-0041 "Banana" input adapter	3-17	1004 Hz Data and Parameter Displays	9-4, 9-5
30-0033XT Signalling Adapter with Ring Generator	3-17	1004 Hz Parameter Display/Adjustment	9-4
		1004 Hz TONE (1004 Hz)	9-3

## A

AC Power Selector Switch	3-15	AM5 Classic Front Panels	3-2
ACCESSORIES	3-18	AM5e Classic Front Panel	3-2
AM3-2A/C Responder	5-10	Arrow keys (up, down, left)	3-8, 3-9
AM3-4A Responder	5-10		

**B**

Bandpass Filter (PGM) .....	7-3	BATTERY PACK .....	2-1, 3-17
Bandwidth Filter (CMSG) .....	7-2	Bell Standard 41009 .....	1-1
Bantam jacks .....	3-5	BRDG (bridging) selection .....	5-4

**C**

CALIBRATION .....	4-7	CMSG Bandwidth Filter .....	7-2
External Test Equipment .....	4-7	CNT (counter) .....	3-8
Policy .....	11-1	COMMERCIAL POWER .....	2-1
Procedure .....	4-8	Construction of unit .....	3-1
Setup .....	4-7	Correct (way to wind power cord) .....	inside front cover
Carrying Handle .....	3-1		
CCITT International Recommendations	1-1, 8-1		
CCITT NOISE WEIGHTING FILTERS	8-1		

**D**

DB .....	3-6	DIAL key .....	3-14
DBm .....	3-6	DIAL terminal DIAL selection .....	5-3
DBrn .....	3-6	DIAL Terminals .....	3-14
DC Path resistance (200Ω or less) .....	3-7	Dimensions .....	3-1
Defaults .....	2-1	DISPLAY (SEND, MEAS) Selections .....	5-6
DEFAULT SETTINGS .....	4-1		

**E**

End-to-End Testing .....	5-8	Evaluation of Noise Measurement Data	6-12
Error during calibration .....	4-9		

**F**

F1, F2, F3, F4 single-frequency tones .....	9-8	Flashing and Non-Flashing Mode .....	3-9
FACTORY-INSTALLED EQUIPMENT		Front Panel .....	3-2
OPTIONS .....	3-17	FRONT PANEL DESCRIPTION .....	3-1
FILTER (right key) .....	3-11	"Full Cal?" message .....	4-1, 4-8
FILTER selections .....	5-5	Fuse Holder and Fuse Type .....	3-15
FILTER (left key) .....	3-11		

**H**

High calibration V1 .....	4-8	HOLD TONE LED .....	3-7
---------------------------	-----	---------------------	-----

**I**

Identification Label coding .....	3-15	IMPULSE NOISE	
IDLE LINE NOISE (NOISE) .....	6-2	WITH TONE (IMP N W/T) .....	6-8
IEEE NOISE WEIGHTING FILTERS .....	7-1	WITHOUT TONE (IMP NOISE) .....	6-8
IEEE Standard 743-1984 .....	1-1, 7-1	Impulse Noise measurement .....	3-10, 6-8
Impedance Selections .....	5-4	Selection/Displays .....	6-10, 6-11
		Illustration .....	6-13
		Measurements and Parameters .....	6-9

**K**



KHz (kiloHertz) ..... 3-8

## L

L/F 15 kHz MEASURE FILTER	7-8	LINE Key selections	3-14
L/F UNWTD	6-2	LINE TERMINATION IMPEDANCES	5-7
L/F UNWTD MEASURE FILTER	8-7	Loop Back Tone	9-9
Left-Hand 7-Segment Display	3-6	Loopback Testing	5-9
LEVEL FREQ	6-2	LOOPBACK TESTS	4-3
Line Cables	3-18, 5-1	Low calibration V2	4-8
LINE FUNCTIONS	5-1	Low Pass Filter (3kHz, 15kHz)	7-4, 7-5
2W selection	5-3		
2W 2.16 $\mu$ F selection	5-3		
4W REVerse selection	5-2		
4W selection	5-2		

## M

MEASURE KEY selection	3-10, 6-1	Memory	2-1, 4-3
MEAS display switch position	3-6	MINutes	3-8
MEAS monitor switch position	5-6	MONITOR (TX, MEAS, RX) Selections	3-6, 5-6
MEASURE FUNCTIONS AND PARAMETERS		mSEC (milliseconds)	3-6
data	4-3		
LEVEL AND FREQUENCY	6-2		
NTG selection	5-6		

## N

NARROW BAND L/F UNWTD measure	6-2	NOISE W/T	6-4
NARROW BAND L/F 15 kHz measure	6-2	Noise Weighting Filters	
NO-SIGNAL, TERMINATED (QUIET)	9-2		6-4, 6-6, 6-8, 6-14, 7-1, 8-1
NOISE	6-2	Non-Flashing mode	3-9
Noise Measurement units	3-10, 6-3	Non-Volatile Memory	2-1
Noise to Ground Measurement Range	6-5	NOTCH NOISE (NOISE W/T) measure	6-4
NOISE TO GROUND (NTG)	6-5		
SEND functions	6-6		
NTG selection	5-6		

## O

OFF HOOK (TX/2W and RX) selection	5-4	OPTIONAL FACTORY INSTALLED	
ON OFF Button (power switch)	3-5	EQUIPMENT	3-17
OPEN CIRCUIT (TX/2W direction)	9-9	OPTIONAL BATTERY PACK	2-1, 3-1
ORGANIZATION OF MANUAL	iii, iv	OVERVIEW	1-1

## P

Padded Carrying Case (87-0070)	3-18	POWER ON AND OFF	2-1
PANEL, front	3-2	POWER ON SELF-TEST	4-1
PANEL, rear	3-15	Power Plug	3-15
PARAM SEL keys	3-8, 3-9	Power on-off switch	3-5
Parameter restoration	4-3	Power Turn-on,	
Portable Dimensions	3-1	Function LEDs at	4-1
Power cord precautions	inside front cover	Parameter Settings at	4-1
		Program Bandpass Filter (PGM)	7-3
		Protective front panel (85-0078)	3-18
		Psophometric Filter (PSHO)	8-2

## Q

QUIET .....	9-2	QUIET selection .....	5-5
Data .....	9-2	QUIET Test .....	4-4
Data Display .....	9-2		
Parameter Displays .....	9-3		

## R

Rack Mounted Dimensions .....	3-1	Rubber Feet .....	3-1
Rack Mounting .....	3-18	RX (Receive)	
REAR PANEL .....	3-15	(left key) .....	3-13
Rear Panel Drawing .....	3-16	(middle key) .....	3-13
Responder , testing with .....	5-10, 5-11	(right key) .....	3-13
Restoring Previous Test Settings .....	4-3	BRDG (bridging) selection .....	5-4
RETURN OF UNIT .....	11-2	bantam jack .....	3-5
REVERSE selection .....	3-5	impedance selection .....	5-4
Right-Hand 7-Segment Display .....	3-8	OFF HOOK .....	5-4
Ring Generator, on 30-0030XT adapter .....	3-17	Monitor .....	3-6, 5-6
		TERM (terminating) selection .....	5-4

## S

Screw Terminal, Ground .....	3-16	SF SKIP Rejection for AM5 Classic .....	9-8
Screw Terminals, T and R .....	3-16	SF SKIP Rejection for AM5e Classic .....	9-8
Screw Terminals, T1 and R1 .....	3-16	SF SKIP selection .....	5-5
		Siemens type "banana" input	
Sealed Lead-Acid Batteries and Integral		adapter (Option 25-0041) .....	3-17
Charger (Option 24-0017) .....	3-17	Signal-to-Noise Ratio measurement .....	6-7
SECONDS .....	3-8	SIGNAL-TO-NOISE RATIO	
SELF TEST CONFIGURATION .....	4-1	(S/N RATIO) .....	6-6
SEND (for NTG) functions .....	6-6	SIGNALING FREQUENCY SKIP	
SEND FUNCTIONS AND PARAMETERS .....	9-1	(SF SKIP) .....	9-8
1004 Hz Data and Parameter Displays .....	9-5	SINGLE FREQUENCY TONES	
QUIET Data Display .....	9-2	(F1, F2, F3, F4) .....	9-8
QUIET Parameter Displays .....	9-3	Sound Unweighted Filter (UNWTD	
QUIET line selection .....	5-5	Q-PEAK/UNWTD RMS) .....	8-3
SWEEP Data and Parameter Display .....	9-7	Sound Weighted Filter	
SF SKIP selection .....	5-5	(SWTD Q-PEAK/SWTD RMS) .....	8-4
VARIABLE Hz Data and		Speaker Volume .....	3-6
Parameter Displays .....	9-5	SPECIFICATIONS .....	10-1
SEND keys		SWEEP GENERATOR (SWEEP) .....	9-6
left key .....	3-12	Data and Parameter Display .....	9-7
middle key .....	3-12	Parameter Display/Adjustment .....	9-6
right key .....	3-12	Switch, AC Power Selector .....	3-15
SEND, MEAS		SWTD Q-PEAK filter .....	8-4
Display switch Selection .....	5-6	SWTD RMS filter .....	8-4
Serial number .....	3-15		
SERVICE POLICY .....	11-1		

## T

TABLE OF CONTENTS .....	v	Test Setup	
TERM or BRDG selection .....	5-4	for Impulse Noise without Tone .....	6-14
Terminals .....	3-4, 3-16	for Loopback Test .....	4-4, 5-9
TERMINATED (QUIET) .....	9-2	for NTG .....	6-6
		for S/N Ratio .....	6-8
TEST, LOOPBACK			
Loopback .....	4-3		
QUIET .....	4-4		
SEND 1004 Hz .....	4-6		
TEST CONFIGURATIONS .....	5-8		
Test Setup			
for End-to-End Test .....	5-8		
for Idle Line Noise .....	6-4		
for Impulse Noise with Tone .....	6-14		

## U

Units of Measurement LED's .....	3-8	UNWTD Q-PEAK .....	8-3
UNPACKING .....	1-1	UNWTD RMS .....	8-3

## V

V1 high calibration .....	4-8	VARIABLE FREQUENCY GENERATOR	
V2 low calibration .....	4-8	Parameter Display/Adjustment ...	9-4, 9-5
VARIABLE FREQUENCY GENERATOR		Volume Control .....	3-6
(VAR Hz) Data Display .....	9-4		

## W

WARRANTY .....	11-1	Wideband 160 kHz Filter	
Weight .....	3-1	(WIDE — AM5-200 Model) .....	7-7
Western Electric Model 829 Responder .....	5-8	(WIDE —AM5e-120 Model) .....	8-6
Wideband 120 kHz Filter		Wrong (way to wind power	
(WIDE —AM5-120 Model) .....	7-7	cord) .....	inside front cover
(WIDE —AM5e-120 Model) .....	8-6		



Ameritec is dedicated to serving the worldwide telecommunications community by providing competitively priced, state-of-the-art test equipment that is supported by the finest in marketing, engineering development and customer service.

**Ameritec**

760 Arrow Grand Circle  
Covina, CA 91722 USA  
TEL 626.915.5441  
FAX 626.915.7181  
[www.ameritec.com](http://www.ameritec.com)